

## 22217 EK SKF

Spherical roller bearings

TYPE: Roller bearings, Spherical, Double row, Radial, self-aligning, tapered bore

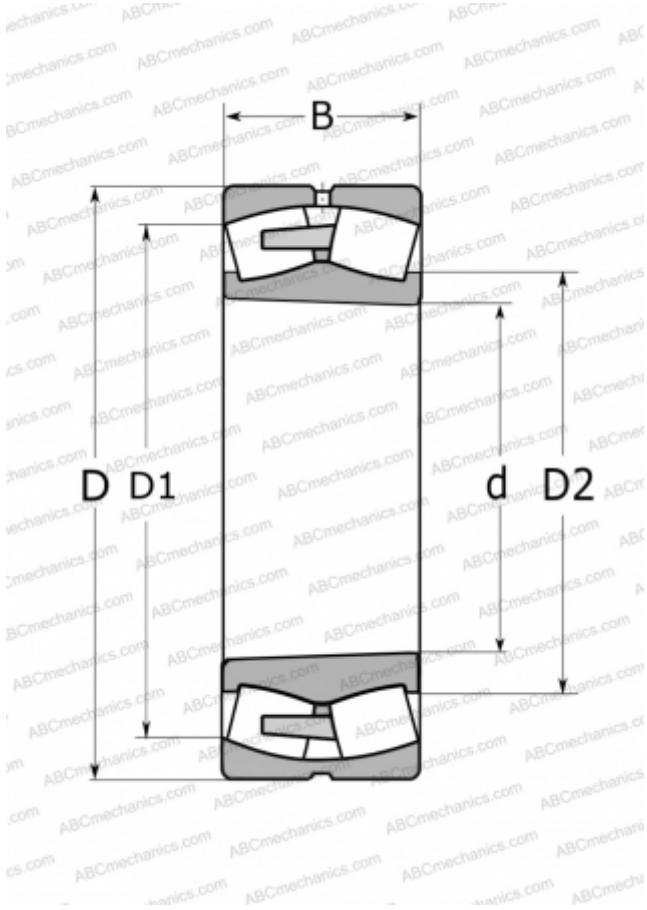

### Technical specification

#### DIMENSIONS, MM

d	85,000
D	150,000
D1	133,000
D2	101,000
B	36,000

#### WEIGHT, KG

2,650

#### MANUFACTURER

[SKF](#)

#### CALCULATION DATA

Basic dynamic load rating, C	285,000 kN
Basic static load rating, Co	325,000 kN
Fatigue load limit, Pu	34,500 kN
Reference speed	4000 r/min
Limiting speed	5600 r/min