

23120 CCK/W33 SKF

Spherical roller bearings

TYPE: Roller bearings, Spherical, Double row, Radial, self-aligning, tapered bore

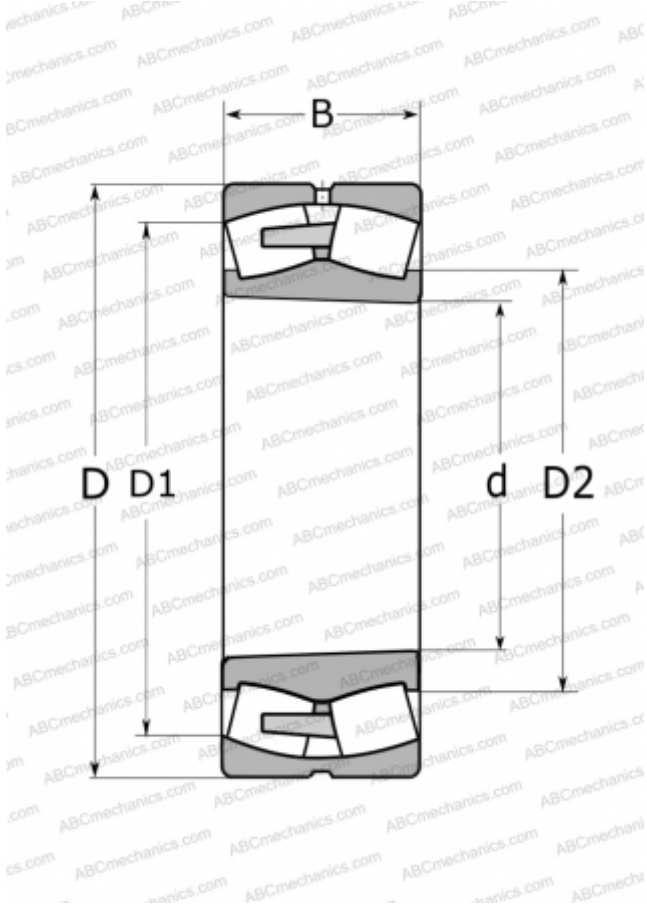

Technical specification

DIMENSIONS, MM

d	100,000
D	165,000
D1	144,000
D2	115,000
B	52,000

WEIGHT, KG

4,550

MANUFACTURER

[SKF](#)

CALCULATION DATA

Basic dynamic load rating, C	365,000 kN
Basic static load rating, Co	490,000 kN
Fatigue load limit, Pu	53,000 kN
Reference speed	3000 r/min
Limiting speed	4000 r/min