

## 22220 EK SKF

Spherical roller bearings

TYPE: Roller bearings, Spherical, Double row, Radial, self-aligning, tapered bore

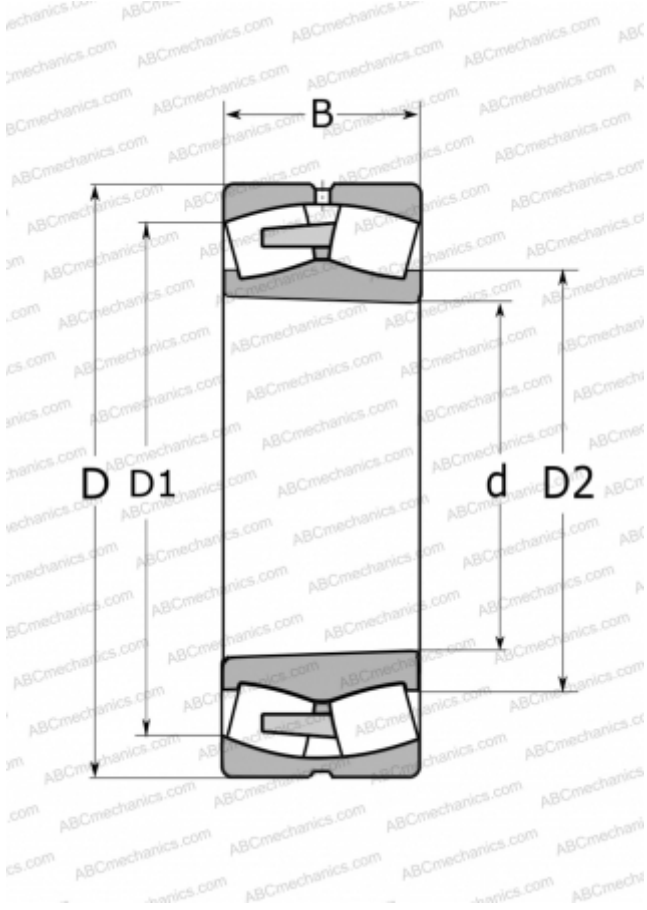

### Technical specification

#### DIMENSIONS, MM

d	100,000
D	180,000
D1	159,000
D2	118,000
B	46,000

#### WEIGHT, KG

4,900

#### MANUFACTURER

[SKF](#)

#### CALCULATION DATA

Basic dynamic load rating, C	425,000 kN
Basic static load rating, Co	490,000 kN
Fatigue load limit, Pu	49,000 kN
Reference speed	3400 r/min
Limiting speed	4500 r/min