

22226 EK SKF

Spherical roller bearings

TYPE: Roller bearings, Spherical, Double row, Radial, self-aligning, tapered bore

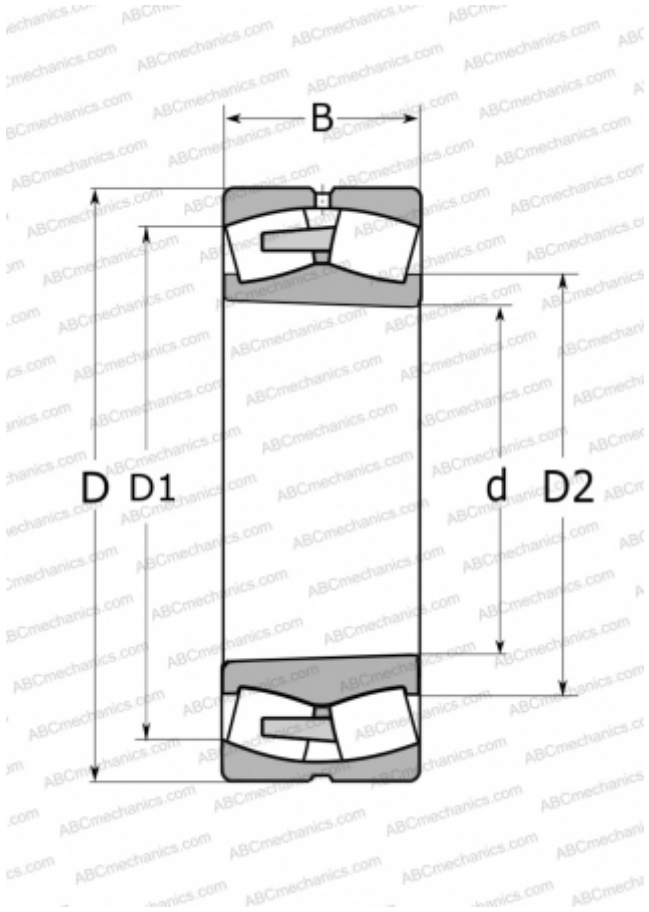

Technical specification

DIMENSIONS, MM

d	130,000
D	230,000
D1	201,000
D2	152,000
B	64,000

WEIGHT, KG

11,000

MANUFACTURER

[SKF](#)

CALCULATION DATA

Basic dynamic load rating, C	735,000 kN
Basic static load rating, Co	930,000 kN
Fatigue load limit, Pu	88,000 kN
Reference speed	2600 r/min
Limiting speed	3600 r/min