

23030 CCK/W33 SKF

Spherical roller bearings

TYPE: Roller bearings, Spherical, Double row, Radial, self-aligning, tapered bore

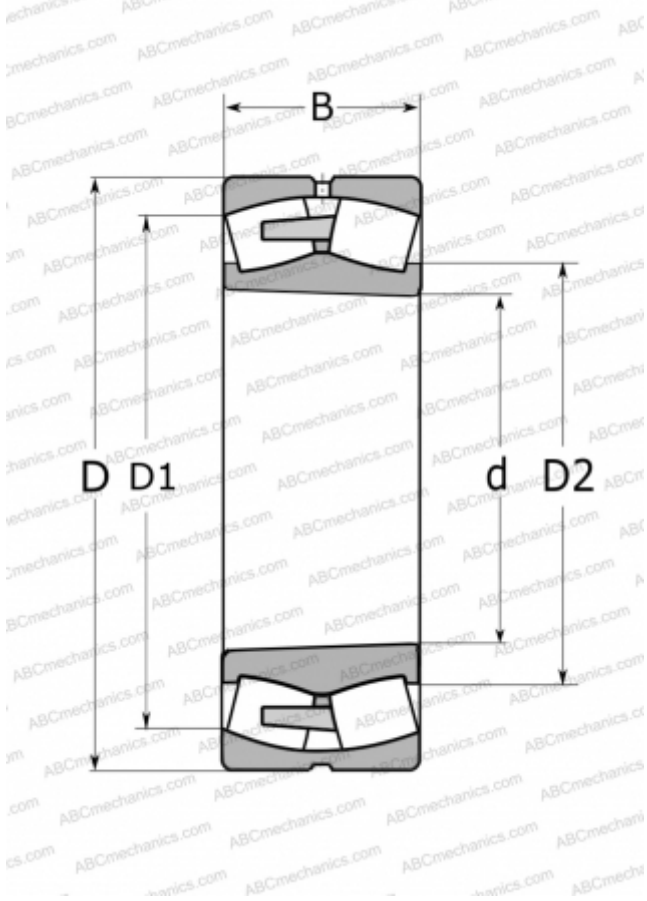

Technical specification

DIMENSIONS, MM

d	150,000
D	225,000
D1	203,000
D2	169,000
B	56,000

WEIGHT, KG

7,950

MANUFACTURER

[SKF](#)

CALCULATION DATA

Basic dynamic load rating, C	510,000 kN
Basic static load rating, Co	750,000 kN
Fatigue load limit, Pu	73,500 kN
Reference speed	2400 r/min
Limiting speed	3200 r/min