

23230 CCK/W33 SKF

Spherical roller bearings

TYPE: Roller bearings, Spherical, Double row, Radial, self-aligning, tapered bore

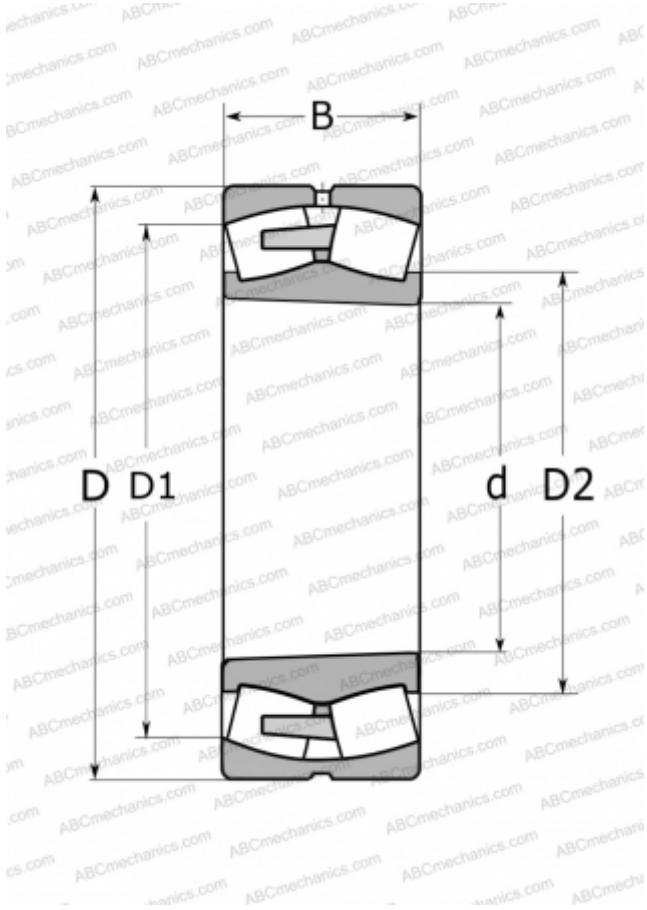

Technical specification

DIMENSIONS, MM

d	150,000
D	270,000
D1	228,000
D2	175,000
B	96,000

WEIGHT, KG

24,500

MANUFACTURER

[SKF](#)

CALCULATION DATA

Basic dynamic load rating, C	1080,000 kN
Basic static load rating, Co	1460,000 kN
Fatigue load limit, Pu	137,000 kN
Reference speed	1600 r/min
Limiting speed	2200 r/min