

23136 CCK/W33 SKF

Spherical roller bearings

TYPE: Roller bearings, Spherical, Double row, Radial, self-aligning, tapered bore

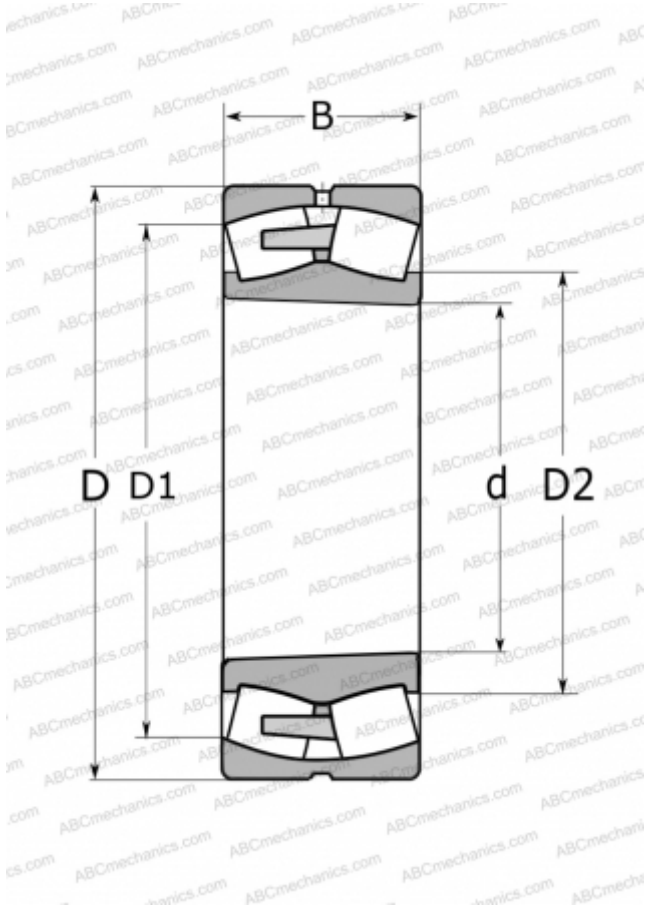

Technical specification

DIMENSIONS, MM

d	180,000
D	300,000
D1	259,000
D2	207,000
B	96,000

WEIGHT, KG

28,000

MANUFACTURER

[SKF](#)

CALCULATION DATA

Basic dynamic load rating, C	1200,000 kN
Basic static load rating, Co	1760,000 kN
Fatigue load limit, Pu	160,000 kN
Reference speed	1700 r/min
Limiting speed	2200 r/min