

23236 CCK/W33 SKF

Spherical roller bearings

TYPE: Roller bearings, Spherical, Double row, Radial, self-aligning, tapered bore

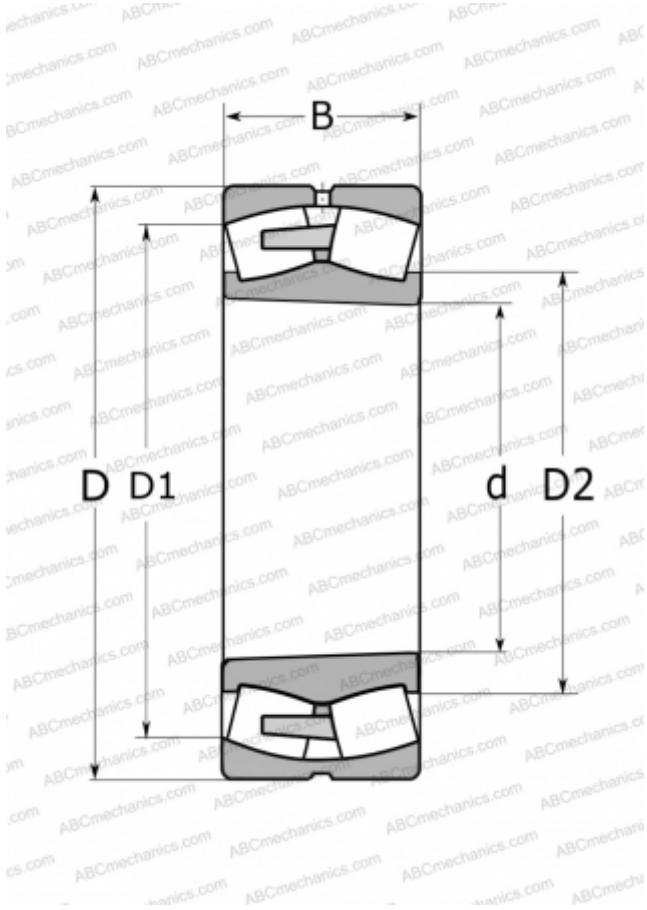

Technical specification

DIMENSIONS, MM

d	180,000
D	320,000
D1	271,000
D2	211,000
B	112,000

WEIGHT, KG

39,500

MANUFACTURER

[SKF](#)

CALCULATION DATA

Basic dynamic load rating, C	1500,000 kN
Basic static load rating, Co	2120,000 kN
Fatigue load limit, Pu	186,000 kN
Reference speed	1300 r/min
Limiting speed	1900 r/min