

22338 CCK/W33 SKF

Spherical roller bearings

TYPE: Roller bearings, Spherical, Double row, Radial, self-aligning, tapered bore

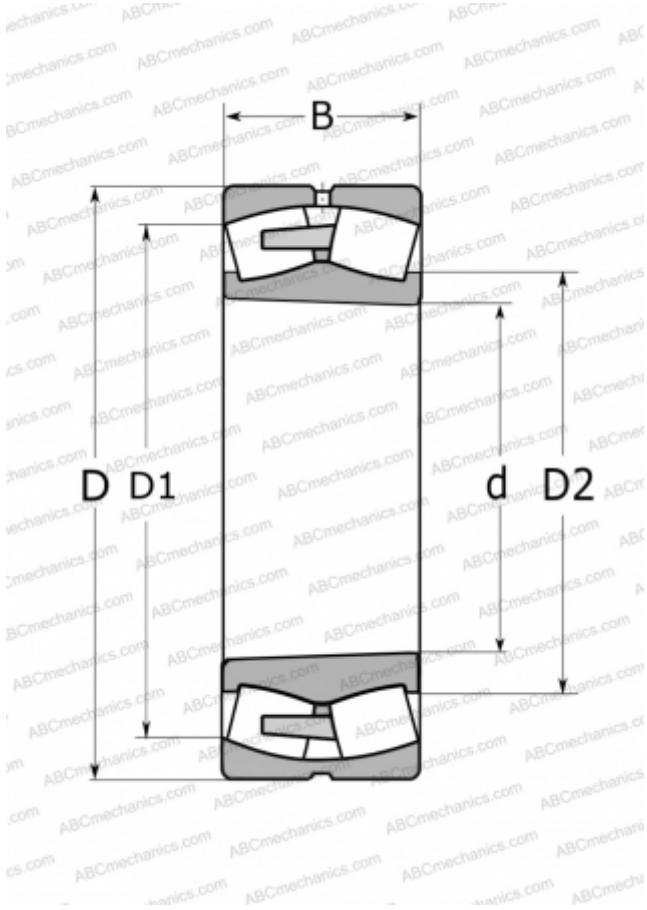

Technical specification

DIMENSIONS, MM

d	190,000
D	400,000
D1	333,000
D2	236,000
B	132,000

WEIGHT, KG

82,500

MANUFACTURER

[SKF](#)

CALCULATION DATA

Basic dynamic load rating, C	2120,000 kN
Basic static load rating, Co	2650,000 kN
Fatigue load limit, Pu	208,000 kN
Reference speed	1200 r/min
Limiting speed	1600 r/min