

23944 CCK/W33 SKF

Spherical roller bearings

TYPE: Roller bearings, Spherical, Double row, Radial, self-aligning, tapered bore

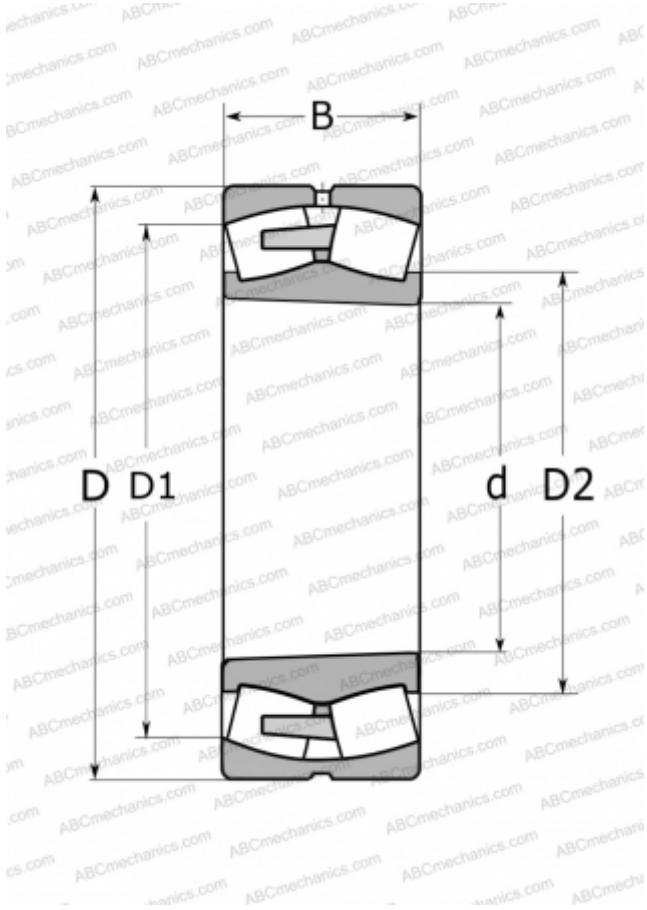

Technical specification

DIMENSIONS, MM

d	220,000
D	300,000
D1	278,000
D2	241,000
B	60,000

WEIGHT, KG

12,500

MANUFACTURER

[SKF](#)

CALCULATION DATA

Basic dynamic load rating, C	546,000 kN
Basic static load rating, Co	1080,000 kN
Fatigue load limit, Pu	93,000 kN
Reference speed	1900 r/min
Limiting speed	2200 r/min