

22348 CCK/W33 SKF

Spherical roller bearings

TYPE: Roller bearings, Spherical, Double row, Radial, self-aligning, tapered bore

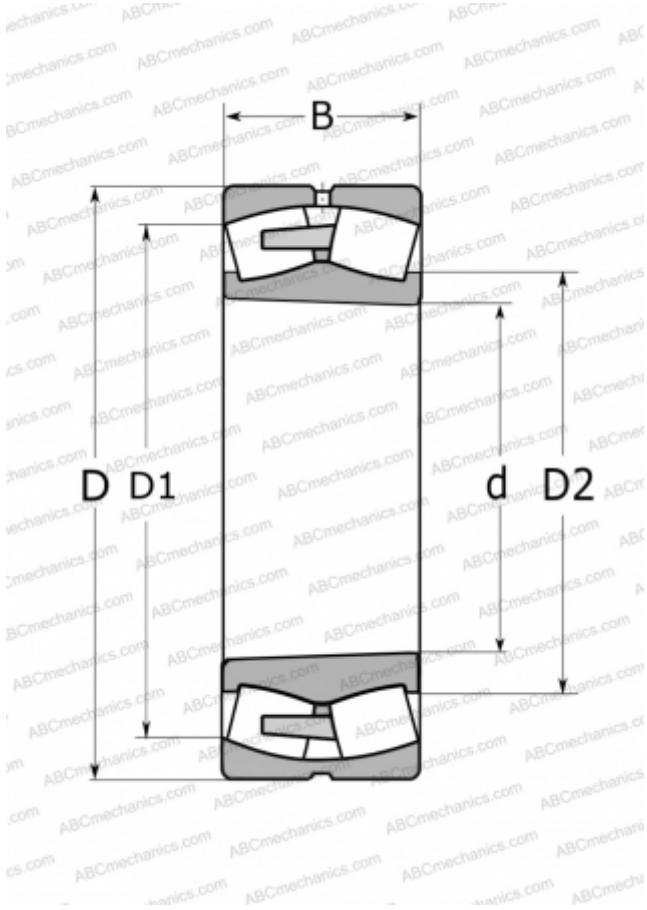

Technical specification

DIMENSIONS, MM

d	240,000
D	500,000
D1	423,000
D2	303,000
B	155,000

WEIGHT, KG

155,000

MANUFACTURER

[SKF](#)

CALCULATION DATA

Basic dynamic load rating, C	3100,000 kN
Basic static load rating, Co	4000,000 kN
Fatigue load limit, Pu	290,000 kN
Reference speed	950 r/min
Limiting speed	1300 r/min