

## 23952 CCK/W33 SKF

Spherical roller bearings

TYPE: Roller bearings, Spherical, Double row, Radial, self-aligning, tapered bore

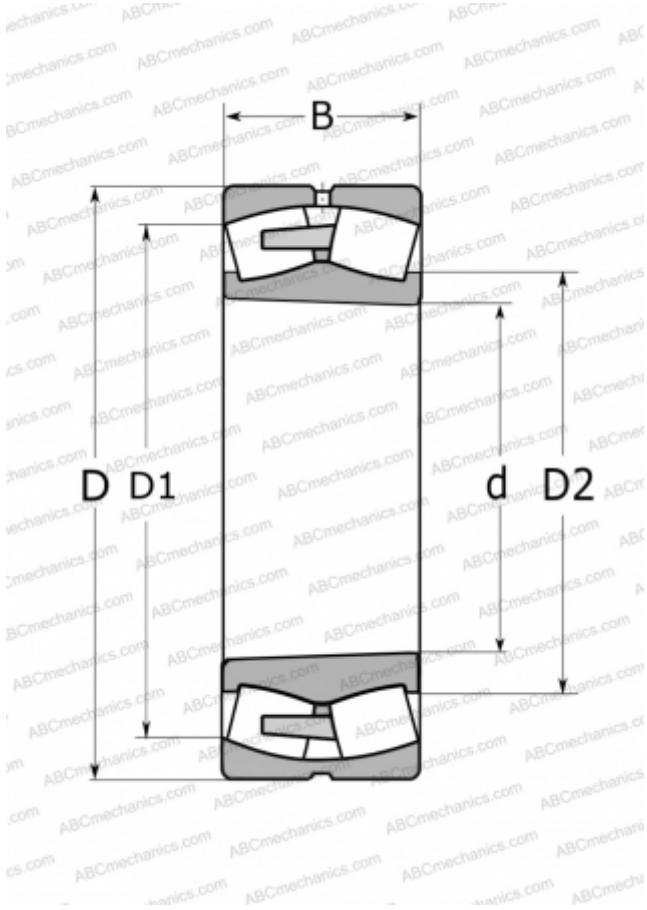

### Technical specification

#### DIMENSIONS, MM

d	260,000
D	360,000
D1	331,000
D2	287,000
B	75,000

#### WEIGHT, KG

23,500

#### MANUFACTURER

[SKF](#)

#### CALCULATION DATA

Basic dynamic load rating, C	880,000 kN
Basic static load rating, Co	1800,000 kN
Fatigue load limit, Pu	156,000 kN
Reference speed	1500 r/min
Limiting speed	1900 r/min