

23256 CCK/W33 SKF

Spherical roller bearings

TYPE: Roller bearings, Spherical, Double row, Radial, self-aligning, tapered bore

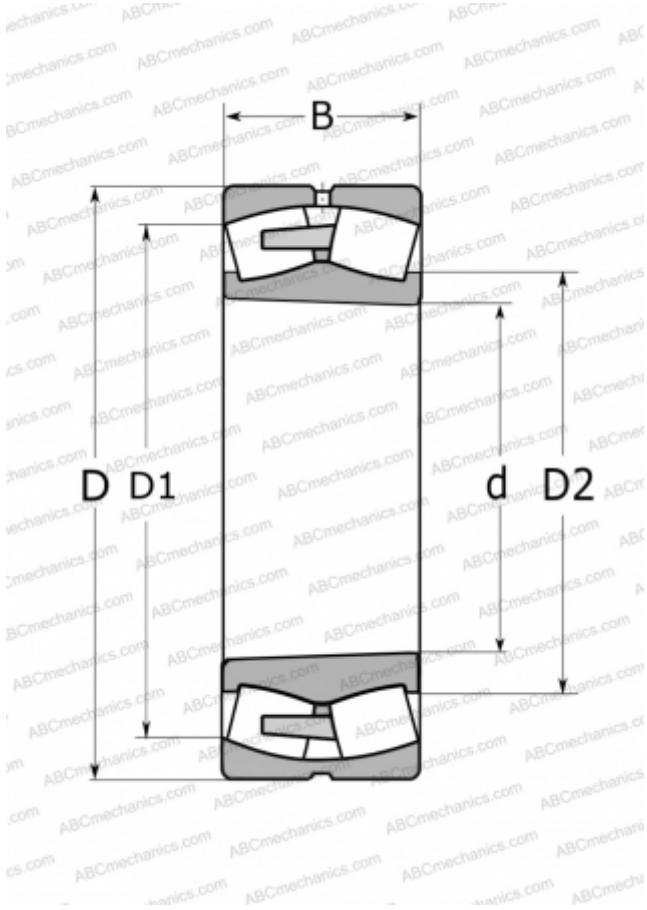

Technical specification

DIMENSIONS, MM

d	280,000
D	500,000
D1	429,000
D2	332,000
B	176,000

WEIGHT, KG

150,000

MANUFACTURER

[SKF](#)

CALCULATION DATA

Basic dynamic load rating, C	3250,000 kN
Basic static load rating, Co	4900,000 kN
Fatigue load limit, Pu	365,000 kN
Reference speed	800 r/min
Limiting speed	1100 r/min