

23060 CCK/W33 SKF

Spherical roller bearings

TYPE: Roller bearings, Spherical, Double row, Radial, self-aligning, tapered bore

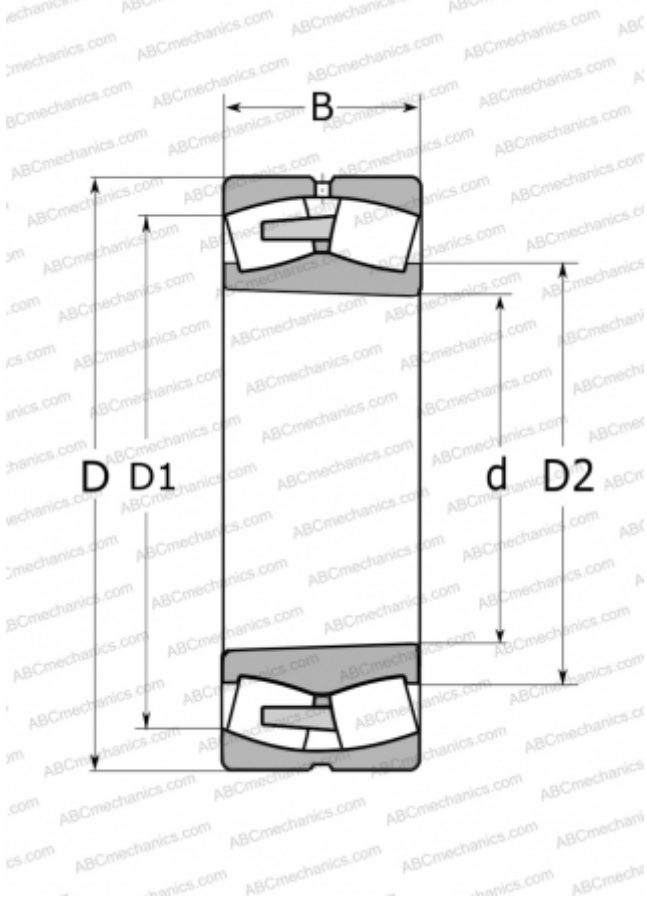

Technical specification

DIMENSIONS, MM

d	300,000
D	460,000
D1	414,000
D2	340,000
B	118,000

WEIGHT, KG

71,500

MANUFACTURER

[SKF](#)

CALCULATION DATA

Basic dynamic load rating, C	2120,000 kN
Basic static load rating, Co	3450,000 kN
Fatigue load limit, Pu	265,000 kN
Reference speed	1200 r/min
Limiting speed	1500 r/min