

23064 CCK/W33 SKF

Spherical roller bearings

TYPE: Roller bearings, Spherical, Double row, Radial, self-aligning, tapered bore

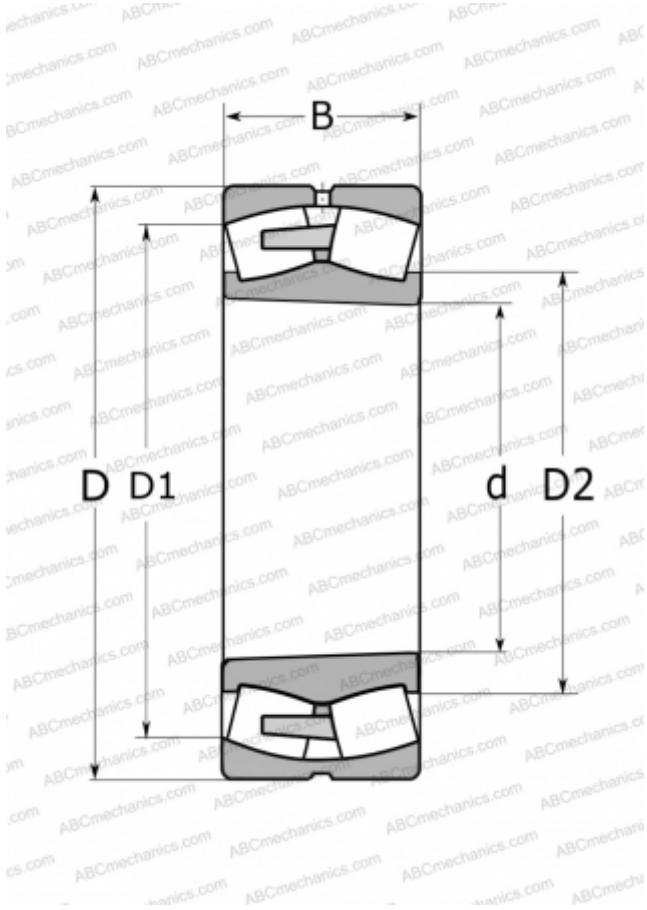

Technical specification

DIMENSIONS, MM

d	320,000
D	480,000
D1	434,000
D2	360,000
B	121,000

WEIGHT, KG

78,000

MANUFACTURER

[SKF](#)

CALCULATION DATA

Basic dynamic load rating, C	2240,000 kN
Basic static load rating, Co	3800,000 kN
Fatigue load limit, Pu	285,000 kN
Reference speed	1100 r/min
Limiting speed	1400 r/min