

23072 CCK/W33 SKF

Spherical roller bearings

TYPE: Roller bearings, Spherical, Double row, Radial, self-aligning, tapered bore

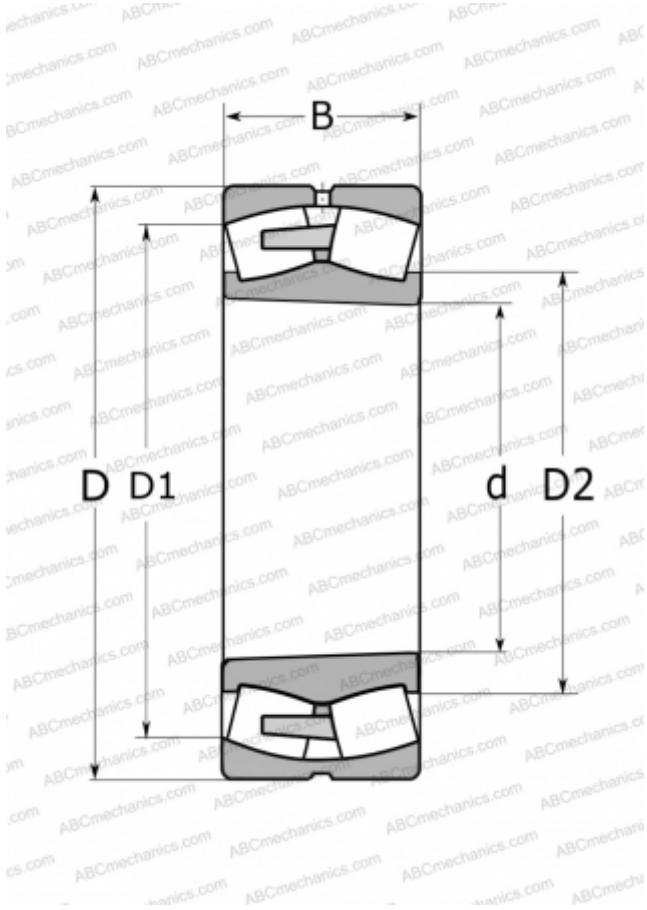

Technical specification

DIMENSIONS, MM

d	360,000
D	540,000
D1	483,000
D2	404,000
B	134,000

WEIGHT, KG

110,000

MANUFACTURER

[SKF](#)

CALCULATION DATA

Basic dynamic load rating, C	2750,000 kN
Basic static load rating, Co	4800,000 kN
Fatigue load limit, Pu	345,000 kN
Reference speed	950 r/min
Limiting speed	1200 r/min