

23980 CCK/W33 SKF

Spherical roller bearings

TYPE: Roller bearings, Spherical, Double row, Radial, self-aligning, tapered bore

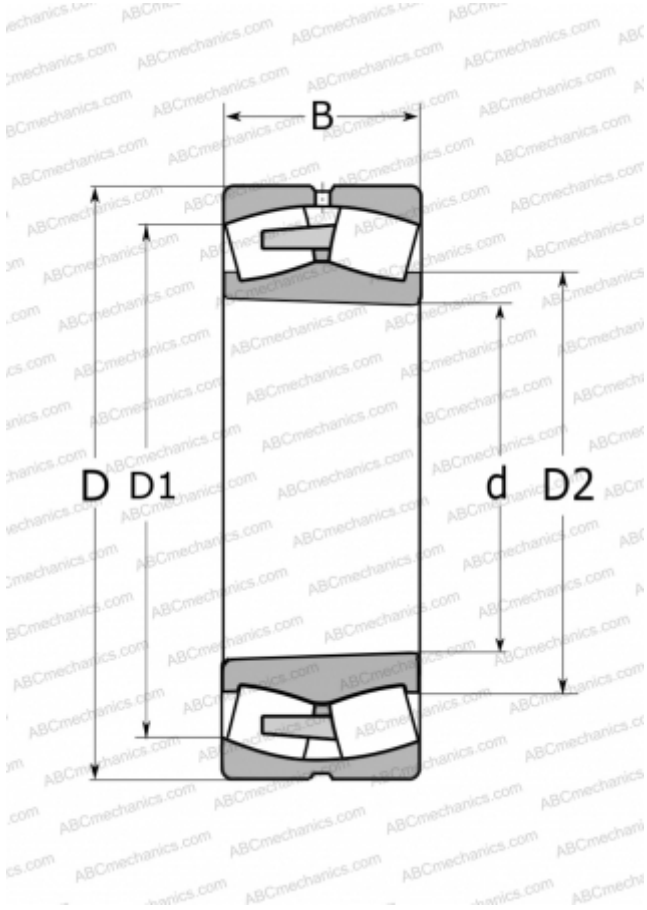

Technical specification

DIMENSIONS, MM

d	400,000
D	540,000
D1	500,000
D2	439,000
B	106,000

WEIGHT, KG

71,000

MANUFACTURER

[SKF](#)

CALCULATION DATA

Basic dynamic load rating, C	2000,000 kN
Basic static load rating, Co	3900,000 kN
Fatigue load limit, Pu	290,000 kN
Reference speed	1100 r/min
Limiting speed	1200 r/min