

## BS2-2208-2CS SKF

Spherical roller bearings

TYPE: Roller bearings, Spherical, Double row, Radial, self-aligning, contact seals on both side

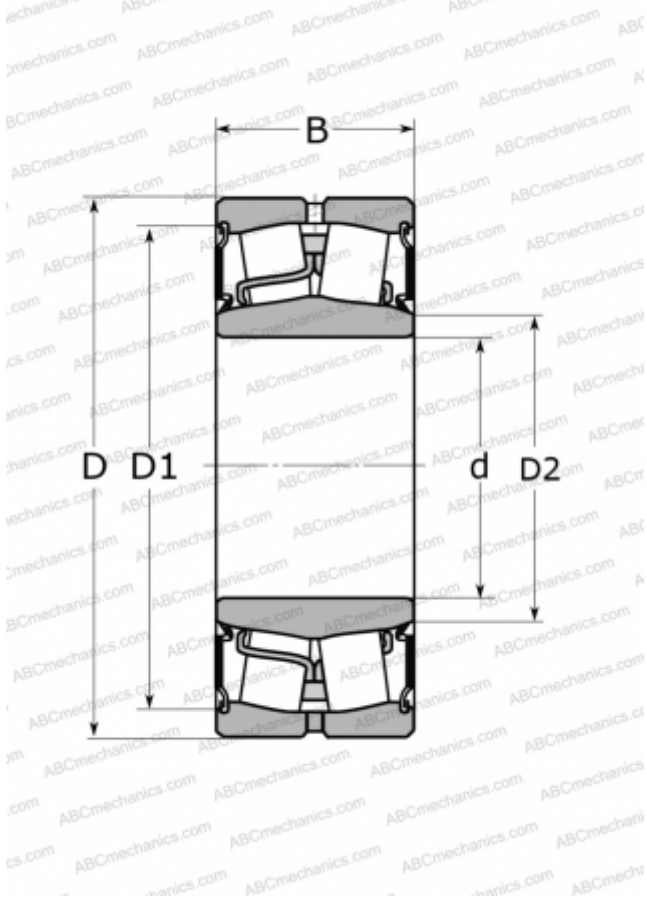

### Technical specification

#### DIMENSIONS, MM

d	40,000
D	80,000
D1	73,000
D2	47,000
B	28,000

#### WEIGHT, KG

0,570

#### MANUFACTURER

[SKF](#)

#### INTERCHANGE

ABC	<a href="#">22208E-2RS</a>
FAG	<a href="#">803019</a>

#### CALCULATION DATA

Basic dynamic load rating, C	96,500 kN
Basic static load rating, Co	90,000 kN
Fatigue load limit, Pu	9,800 kN
Limiting speed	2200 r/min