

BS2-2209-2CS SKF

Spherical roller bearings

TYPE: Roller bearings, Spherical, Double row, Radial, self-aligning, contact seals on both side

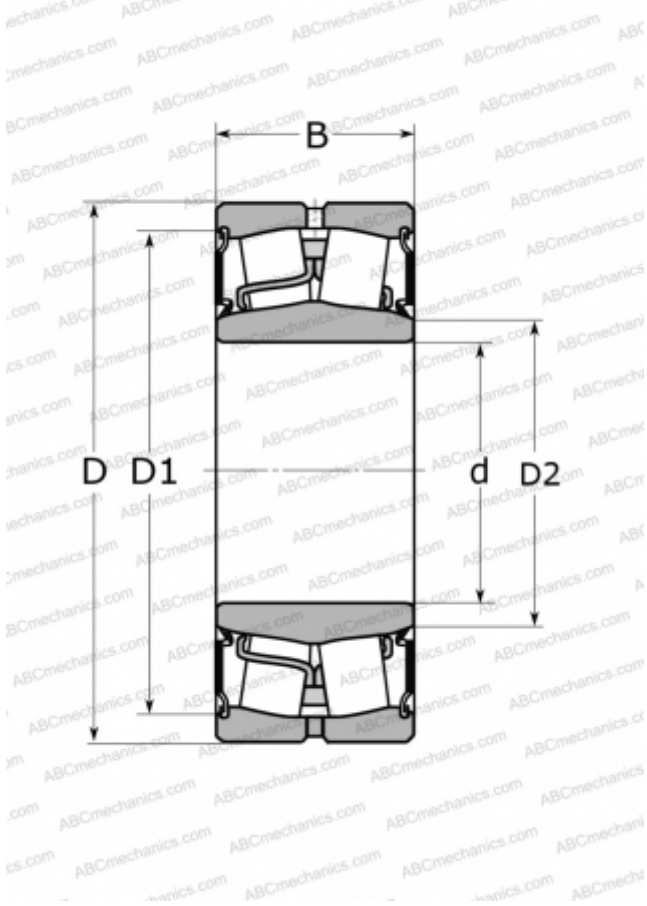

Technical specification

DIMENSIONS, MM

d	45,000
D	85,000
D1	77,100
D2	53,000
B	28,000

WEIGHT, KG

0,660

MANUFACTURER

[SKF](#)

INTERCHANGE

ABC	22209E-2RS
FAG	803020

CALCULATION DATA

Basic dynamic load rating, C	102,000 kN
Basic static load rating, Co	98,000 kN
Fatigue load limit, Pu	10,800 kN
Limiting speed	2000 r/min