

BS2-2215-2CS SKF

Spherical roller bearings

TYPE: Roller bearings, Spherical, Double row, Radial, self-aligning, contact seals on both side

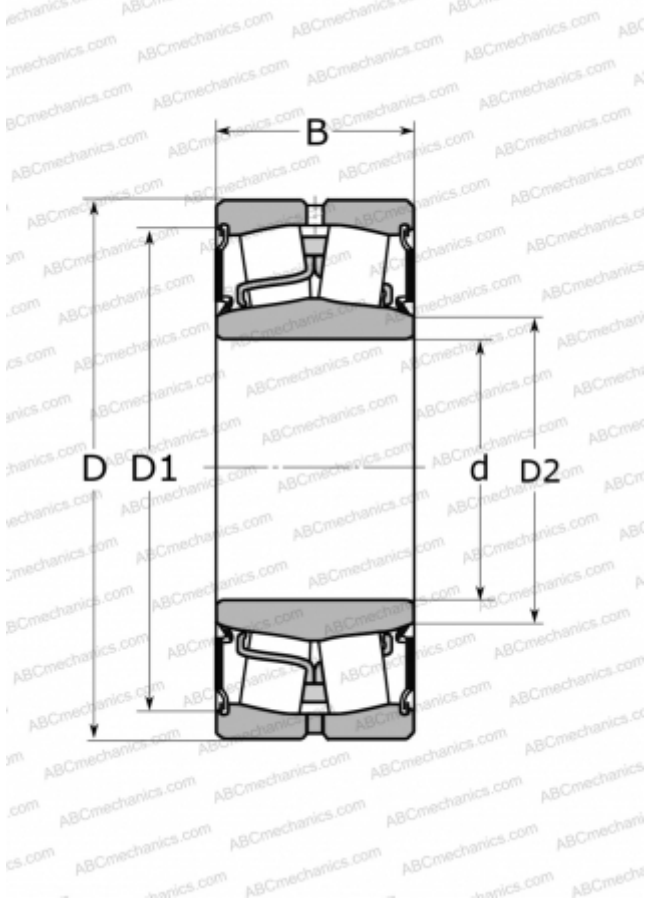

Technical specification

DIMENSIONS, MM

d	75,000
D	130,000
D1	119,000
D2	84,000
B	38,000

WEIGHT, KG

2,100

MANUFACTURER

[SKF](#)

INTERCHANGE

ABC	22215E-2RS
FAG	803025

CALCULATION DATA

Basic dynamic load rating, C	212,000 kN
Basic static load rating, Co	240,000 kN
Fatigue load limit, Pu	26,500 kN
Limiting speed	1300 r/min