

BS2-2216-2CS SKF

Spherical roller bearings

TYPE: Roller bearings, Spherical, Double row, Radial, self-aligning, contact seals on both side

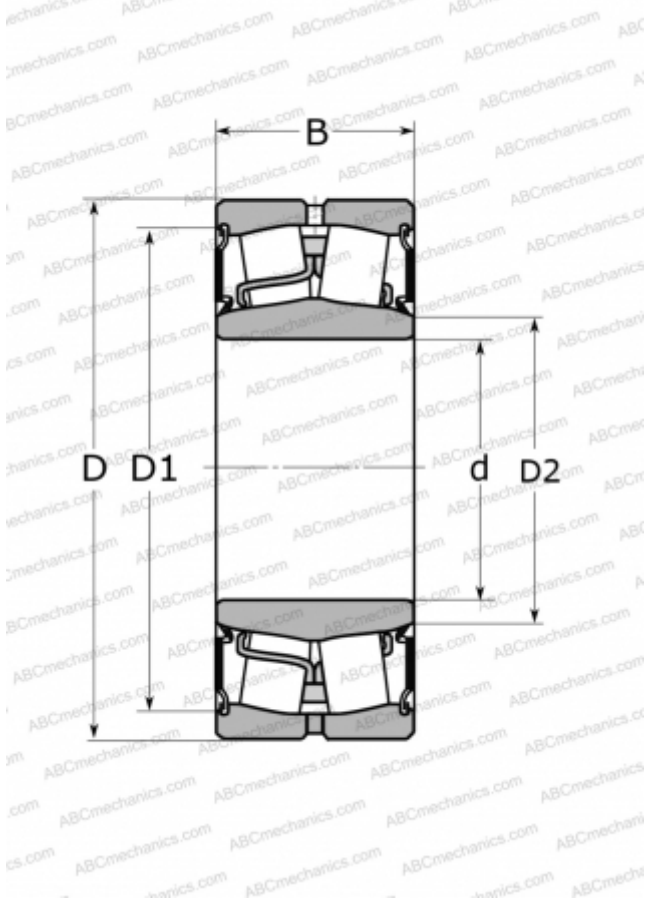

Technical specification

DIMENSIONS, MM

d	80,000
D	140,000
D1	128,000
D2	91,500
B	40,000

WEIGHT, KG

2,400

MANUFACTURER

[SKF](#)

INTERCHANGE

ABC	22216E-2RS
FAG	803026

CALCULATION DATA

Basic dynamic load rating, C	236,000 kN
Basic static load rating, Co	270,000 kN
Fatigue load limit, Pu	29,000 kN
Limiting speed	1200 r/min