

## BS2-2217-2CS SKF

Spherical roller bearings

TYPE: Roller bearings, Spherical, Double row, Radial, self-aligning, contact seals on both side

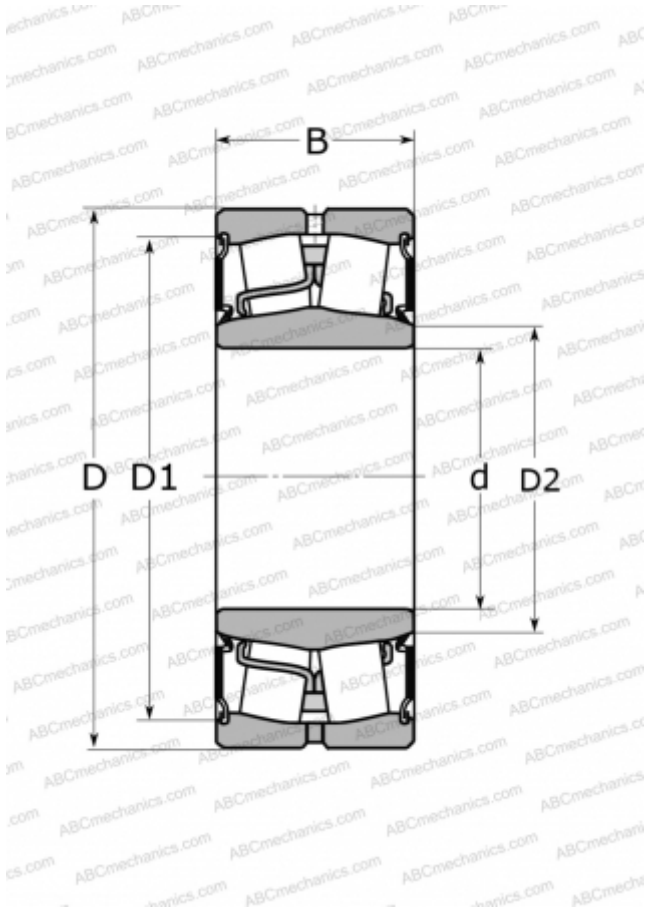

### Technical specification

#### DIMENSIONS, MM

d	85,000
D	150,000
D1	138,000
D2	98,000
B	44,000

#### WEIGHT, KG

3,000

#### MANUFACTURER

[SKF](#)

#### INTERCHANGE

ABC	<a href="#">22217E-2RS</a>
FAG	<a href="#">803015</a>

#### CALCULATION DATA

Basic dynamic load rating, C	285,000 kN
Basic static load rating, Co	325,000 kN
Fatigue load limit, Pu	34,500 kN
Limiting speed	1100 r/min