

22317 EJA/VA405 SKF

Spherical roller bearings

TYPE: Roller bearings, Spherical, Double row, Radial, for vibratory loads

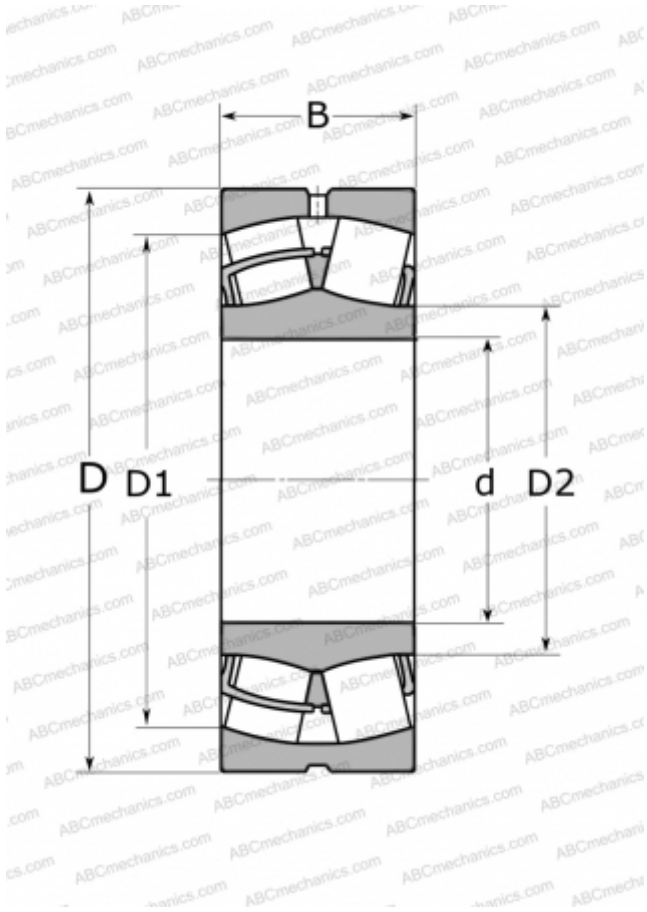

Technical specification

DIMENSIONS, MM

d	85,000
D	180,000
D1	154,000
D2	108,000
B	60,000

WEIGHT, KG

7,650

MANUFACTURER

[SKF](#)

INTERCHANGE

ABC	22317 W33 F80
FAG	22317 E T41A / 22317 EAS MA
NSK	22317 CAME4C4U15-VS
TIMKEN	22317 YMW33W800C4
NTN	22317 UAVS2

CALCULATION DATA

Basic dynamic load rating, C	550,000 kN
Basic static load rating, Co	620,000 kN
Fatigue load limit, Pu	61,000 kN
Reference speed	2800 r/min
Limiting speed	3800 r/min

REPLACES

452317 CACM2/W502