

C 6006 V SKF

CARB toroidal roller bearings

TYPE: Roller bearings, Toroidal CARB, Full complement, cylindrical bore

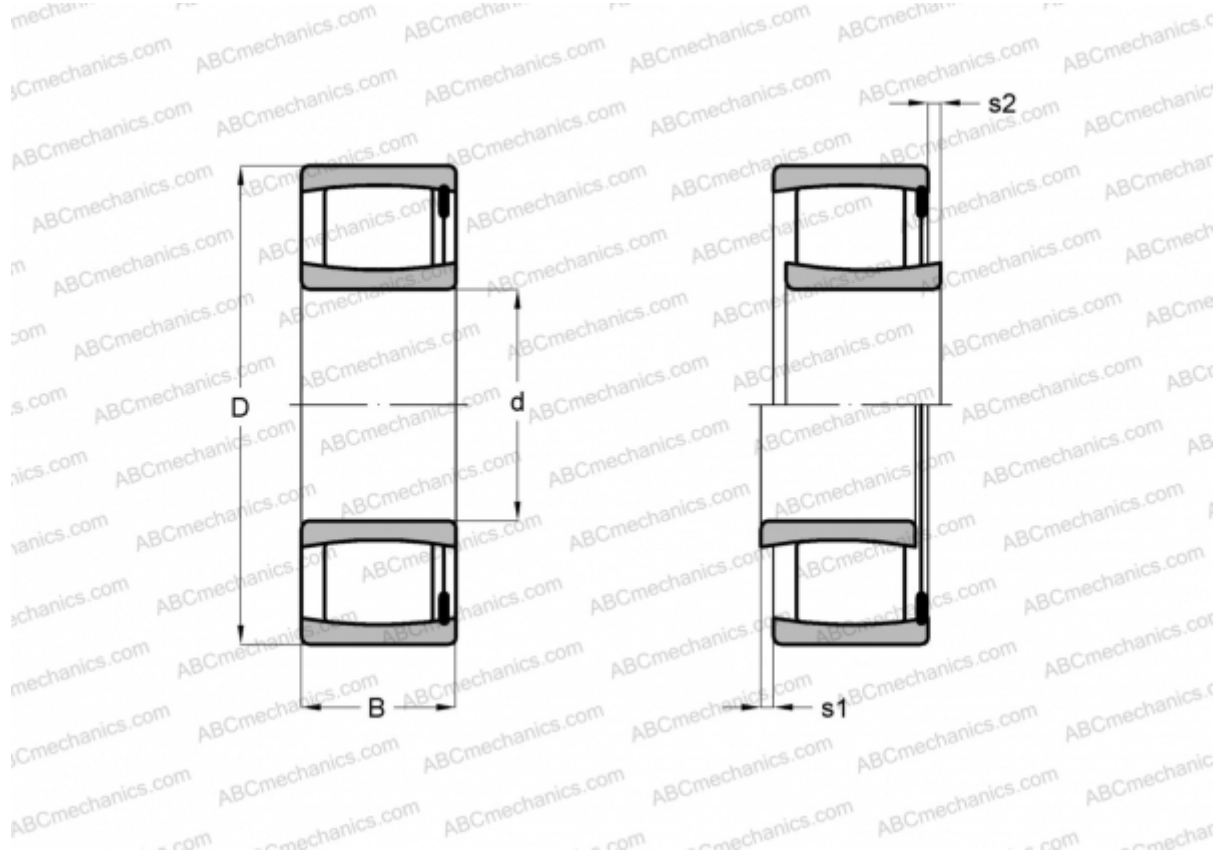

Technical specification

DIMENSIONS, MM

d	30,000
D	55,000
B	45,000

WEIGHT, KG 0,500

MANUFACTURER [SKF](#)

CALCULATION DATA

Basic dynamic load rating, C	134,000 kN
Basic static load rating, Co	180,000 kN
Fatigue load limit, Pu	19,600 kN
Limiting speed	3000 r/min