

C 2206 V SKF

CARB toroidal roller bearings

TYPE: Roller bearings, Toroidal CARB, Full complement, cylindrical bore

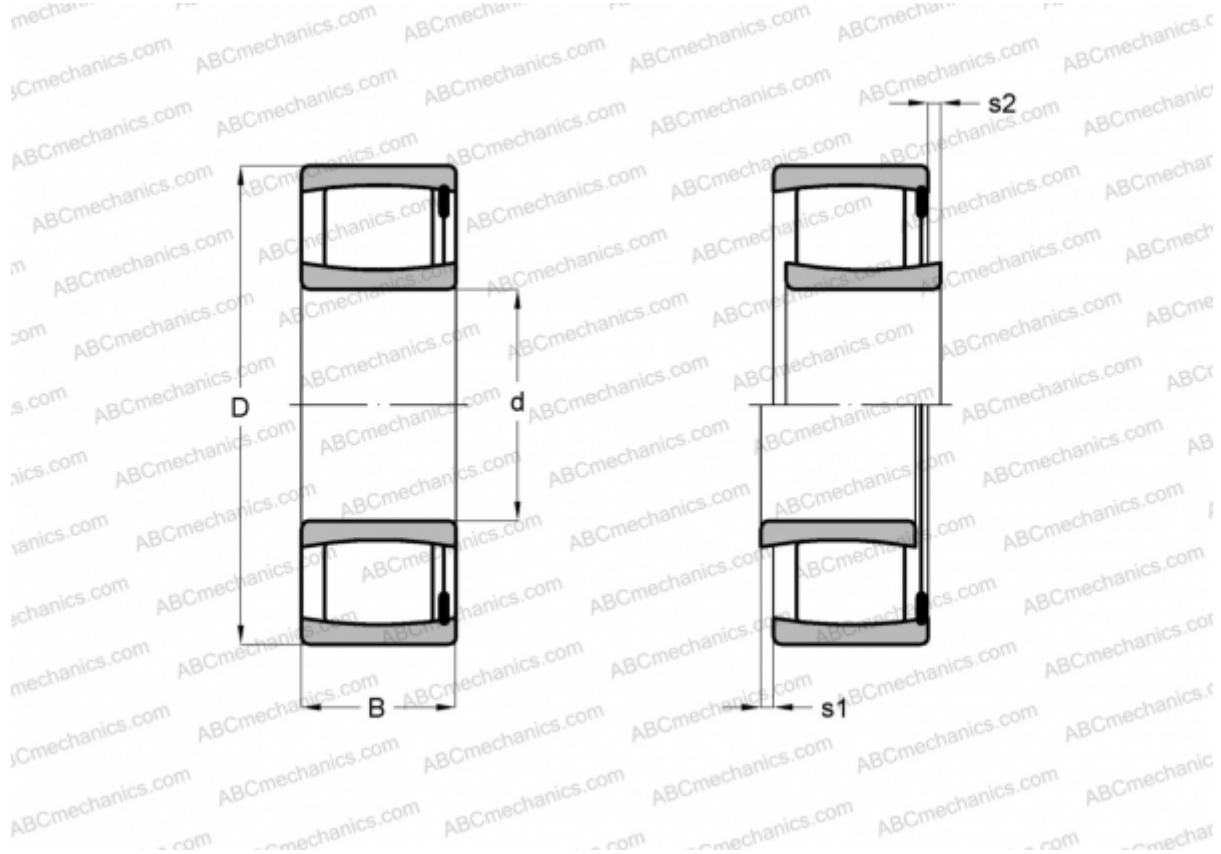

Technical specification

DIMENSIONS, MM

| | |
|---|--------|
| d | 30,000 |
| D | 62,000 |
| B | 20,000 |

WEIGHT, KG 0,290

MANUFACTURER [SKF](#)

CALCULATION DATA

| | |
|------------------------------|------------|
| Basic dynamic load rating, C | 76,500 kN |
| Basic static load rating, Co | 71,000 kN |
| Fatigue load limit, Pu | 8,300 kN |
| Limiting speed | 6000 r/min |