

## C 4908 V SKF

CARB toroidal roller bearings

TYPE: Roller bearings, Toroidal CARB, Full complement, cylindrical bore

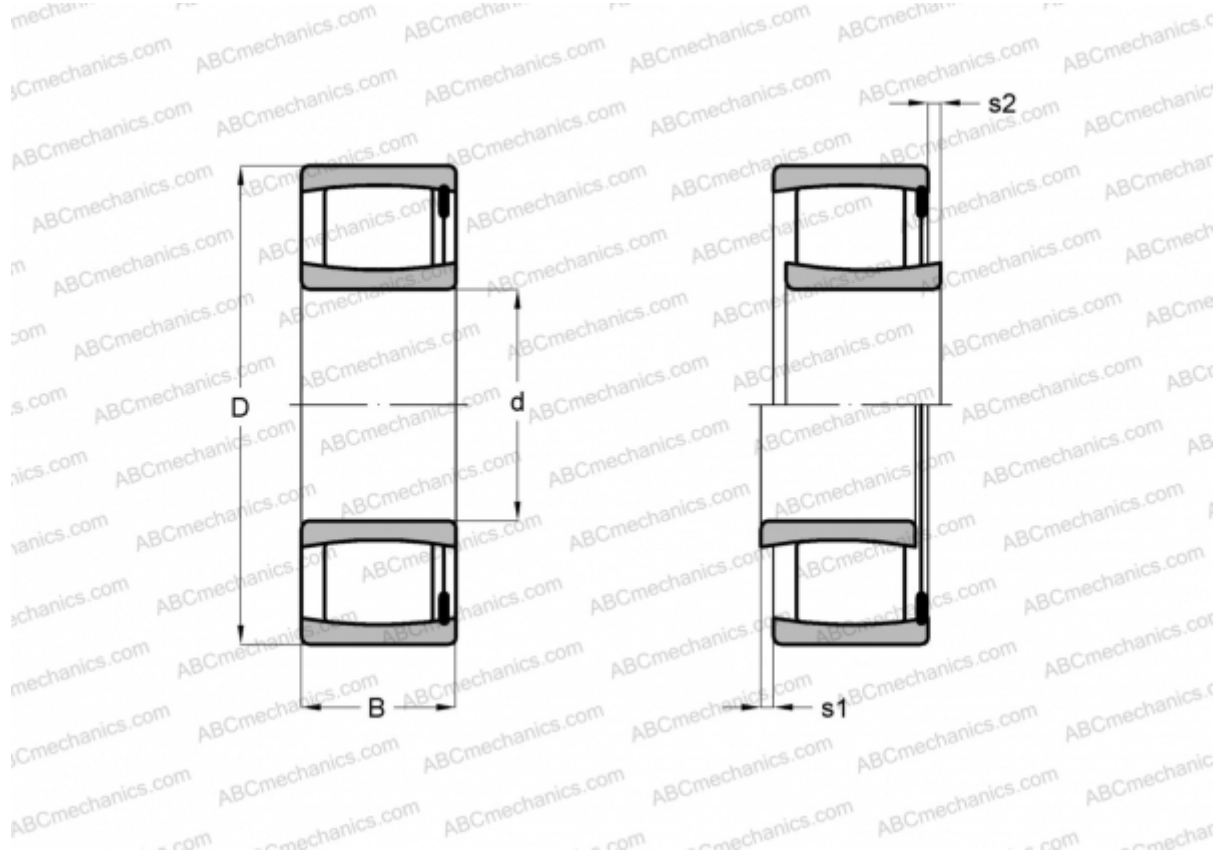

### Technical specification

#### DIMENSIONS, MM

d	40,000
D	62,000
B	22,000

**WEIGHT, KG** 0,250

**MANUFACTURER** [SKF](#)

#### CALCULATION DATA

Basic dynamic load rating, C	76,500 kN
Basic static load rating, Co	100,000 kN
Fatigue load limit, Pu	11,000 kN
Limiting speed	4300 r/min