

C 2208 V SKF

CARB toroidal roller bearings

TYPE: Roller bearings, Toroidal CARB, Full complement, cylindrical bore

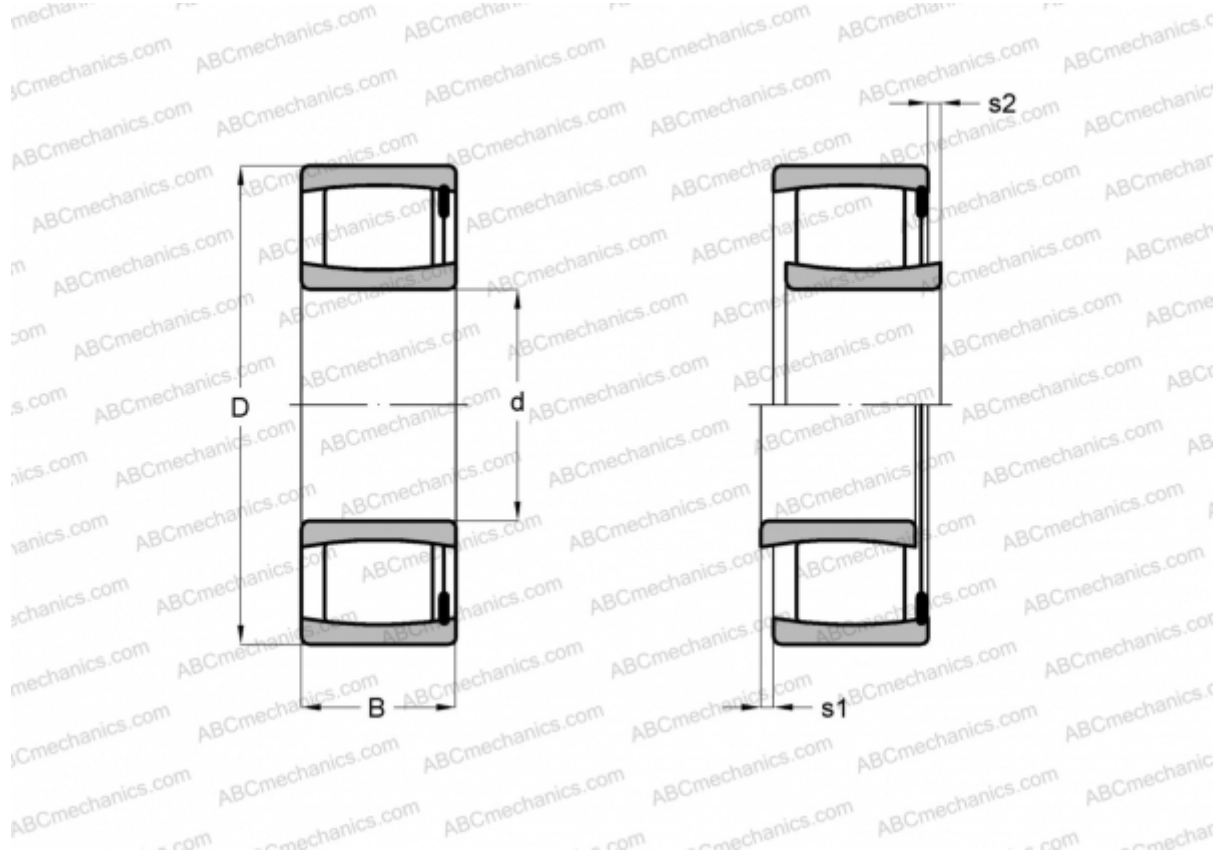

Technical specification

DIMENSIONS, MM

d	40,000
D	80,000
B	23,000

WEIGHT, KG 0,530

MANUFACTURER [SKF](#)

CALCULATION DATA

Basic dynamic load rating, C	102,000 kN
Basic static load rating, Co	104,000 kN
Fatigue load limit, Pu	12,000 kN
Limiting speed	4500 r/min