

C 4909 V SKF

CARB toroidal roller bearings

TYPE: Roller bearings, Toroidal CARB, Full complement, cylindrical bore

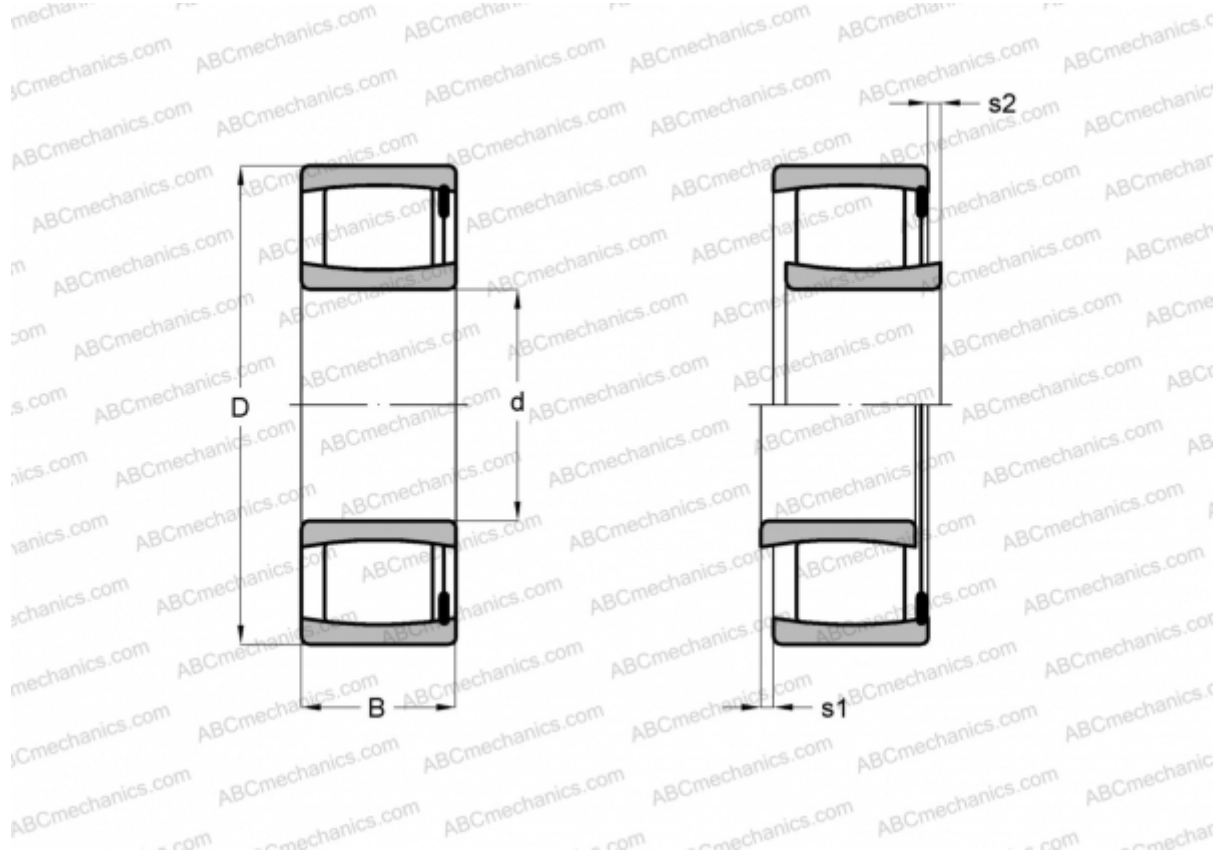

Technical specification

DIMENSIONS, MM

d	45,000
D	68,000
B	22,000

WEIGHT, KG 0,300

MANUFACTURER [SKF](#)

CALCULATION DATA

Basic dynamic load rating, C	81,500 kN
Basic static load rating, Co	112,000 kN
Fatigue load limit, Pu	12,900 kN
Limiting speed	3800 r/min