

C 5909 V SKF

CARB toroidal roller bearings

TYPE: Roller bearings, Toroidal CARB, Full complement, cylindrical bore

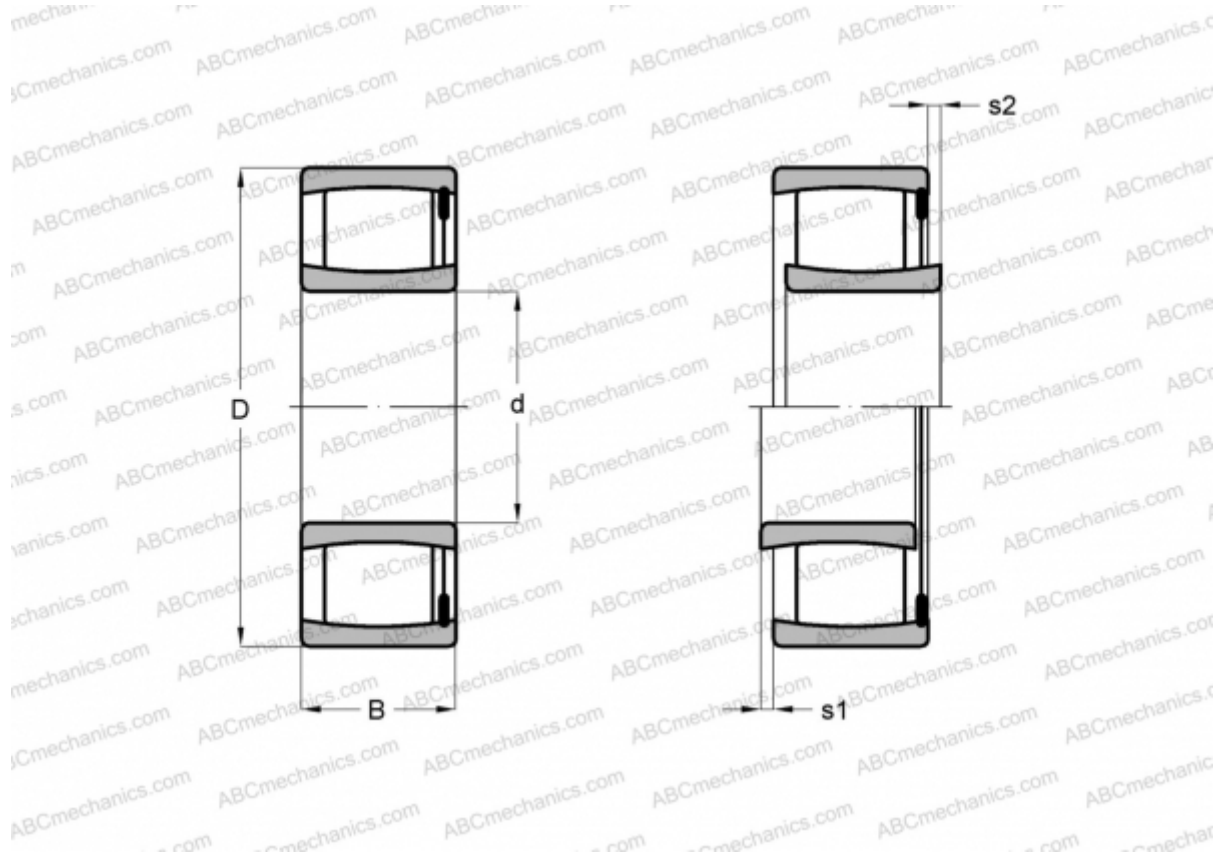

Technical specification

DIMENSIONS, MM

d	45,000
D	68,000
B	30,000

WEIGHT, KG 0,410

MANUFACTURER [SKF](#)

CALCULATION DATA

Basic dynamic load rating, C	110,000 kN
Basic static load rating, Co	163,000 kN
Fatigue load limit, Pu	18,300 kN
Limiting speed	3200 r/min