

C 6909 V SKF

CARB toroidal roller bearings

TYPE: Roller bearings, Toroidal CARB, Full complement, cylindrical bore

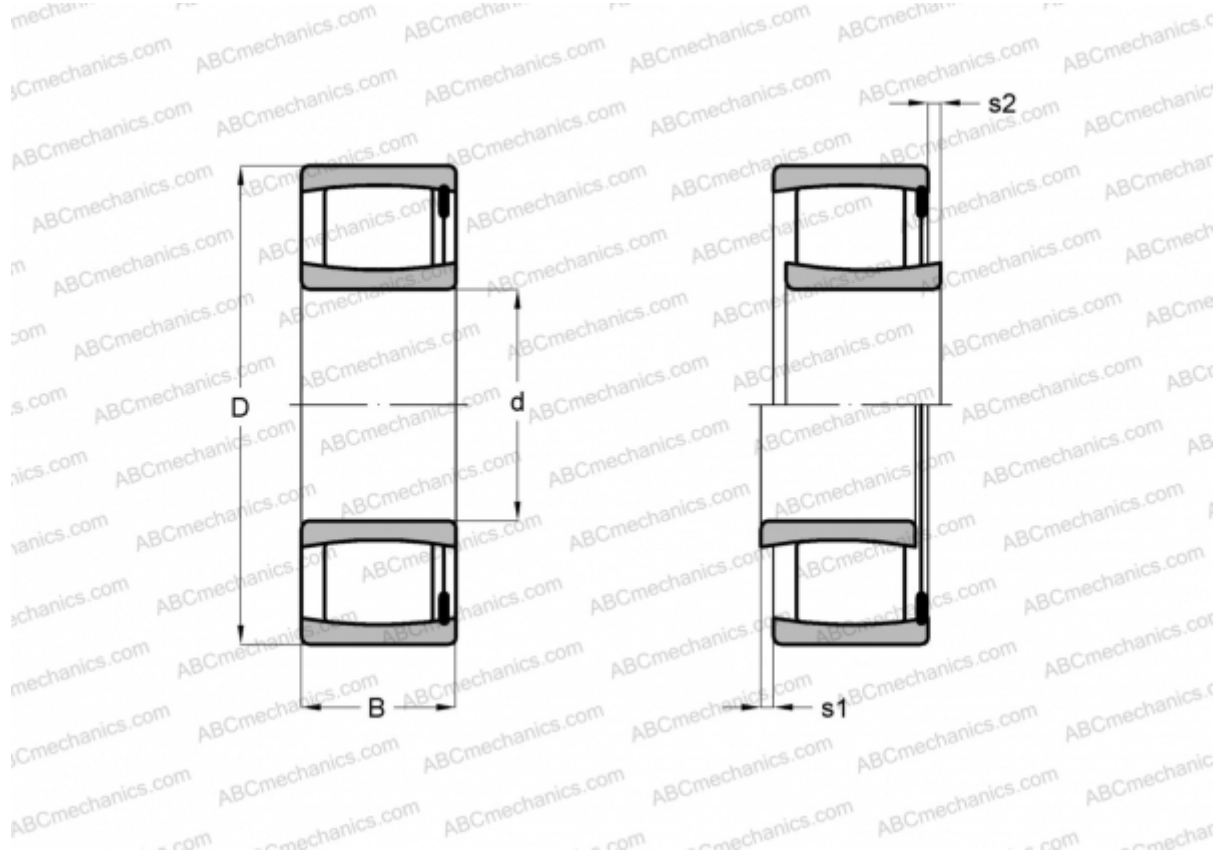

Technical specification

DIMENSIONS, MM

d	45,000
D	68,000
B	40,000

WEIGHT, KG 0,550

MANUFACTURER [SKF](#)

CALCULATION DATA

Basic dynamic load rating, C	132,000 kN
Basic static load rating, Co	200,000 kN
Fatigue load limit, Pu	22,000 kN
Limiting speed	2600 r/min