

C 6910 V SKF

CARB toroidal roller bearings

TYPE: Roller bearings, Toroidal CARB, Full complement, cylindrical bore

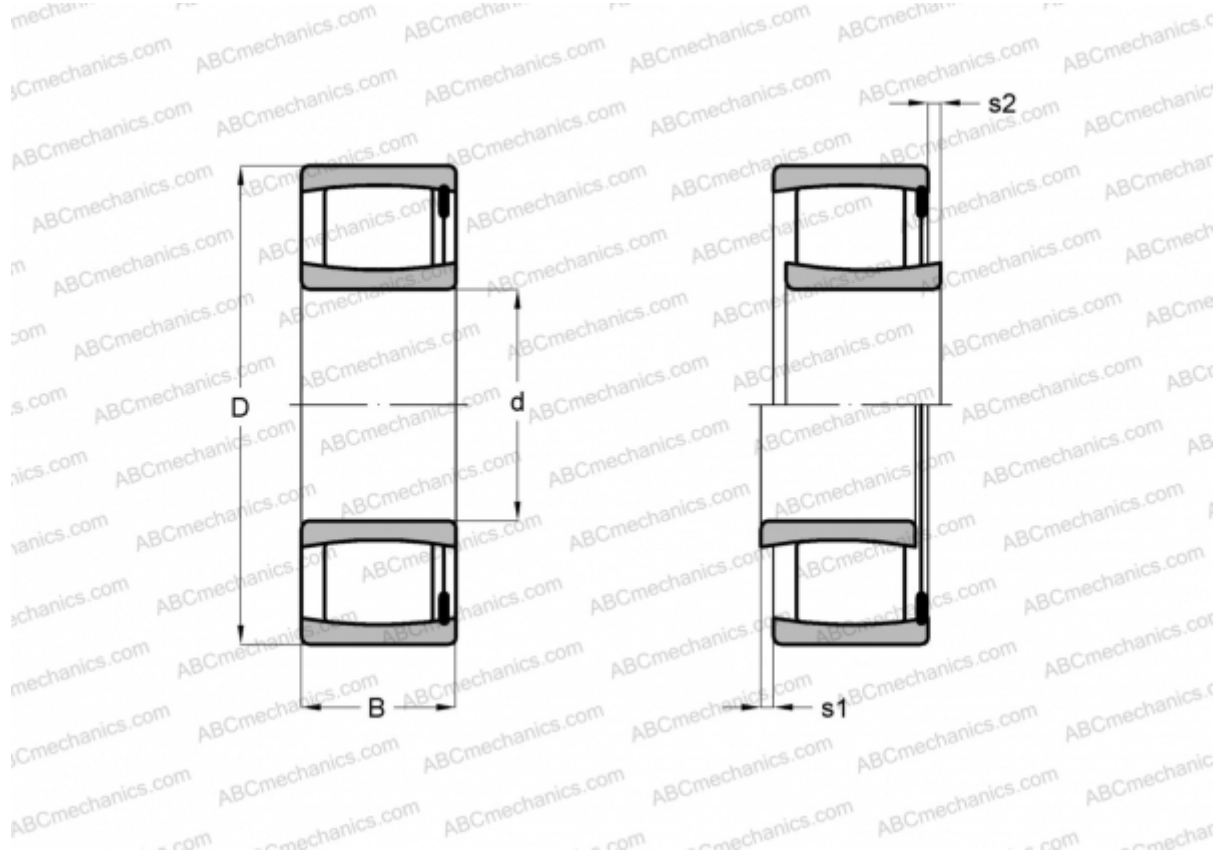

Technical specification

DIMENSIONS, MM

d	50,000
D	72,000
B	40,000

WEIGHT, KG 0,540

MANUFACTURER [SKF](#)

CALCULATION DATA

Basic dynamic load rating, C	140,000 kN
Basic static load rating, Co	224,000 kN
Fatigue load limit, Pu	24,500 kN
Limiting speed	2200 r/min