

C 4010 V SKF

CARB toroidal roller bearings

TYPE: Roller bearings, Toroidal CARB, Full complement, cylindrical bore

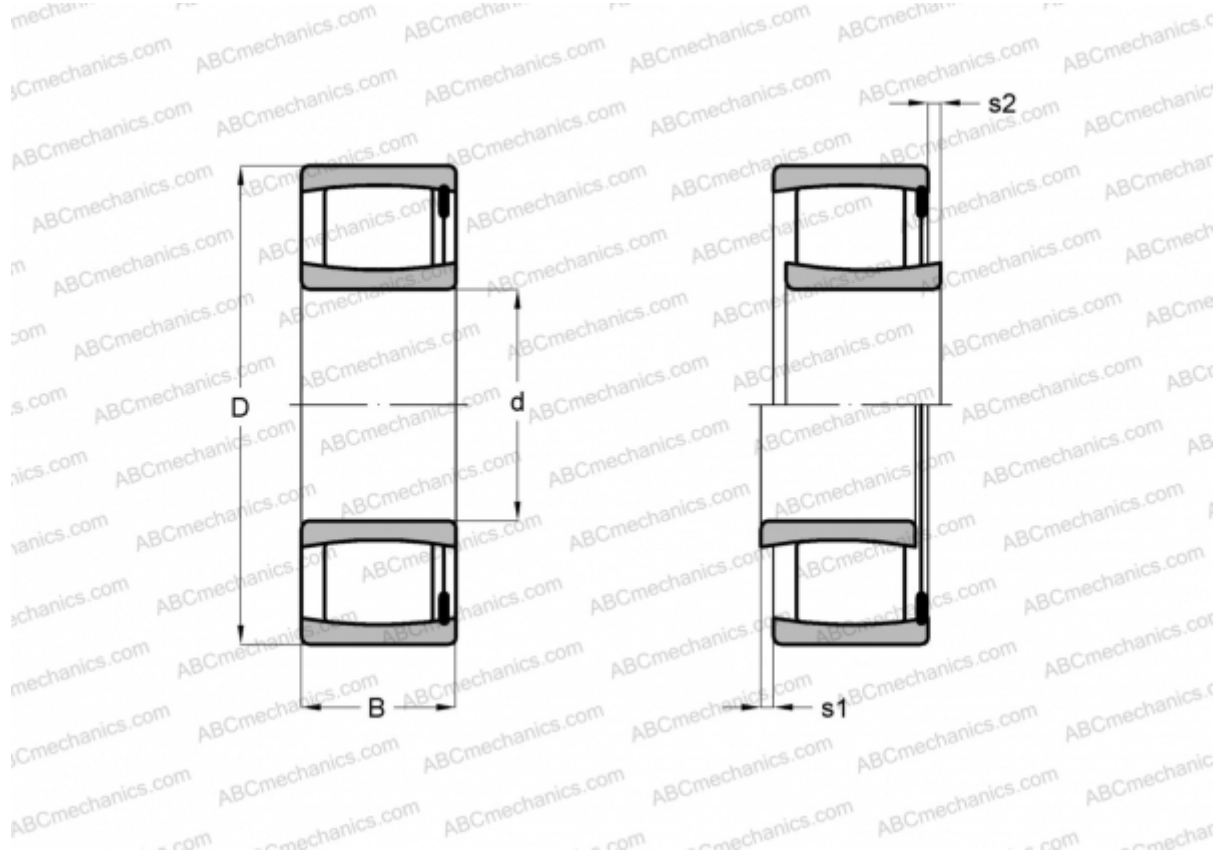

Technical specification

DIMENSIONS, MM

d	50,000
D	80,000
B	30,000

WEIGHT, KG 0,590

MANUFACTURER [SKF](#)

CALCULATION DATA

Basic dynamic load rating, C	137,000 kN
Basic static load rating, Co	176,000 kN
Fatigue load limit, Pu	20,000 kN
Limiting speed	3000 r/min