

C 4911 V SKF

CARB toroidal roller bearings

TYPE: Roller bearings, Toroidal CARB, Full complement, cylindrical bore

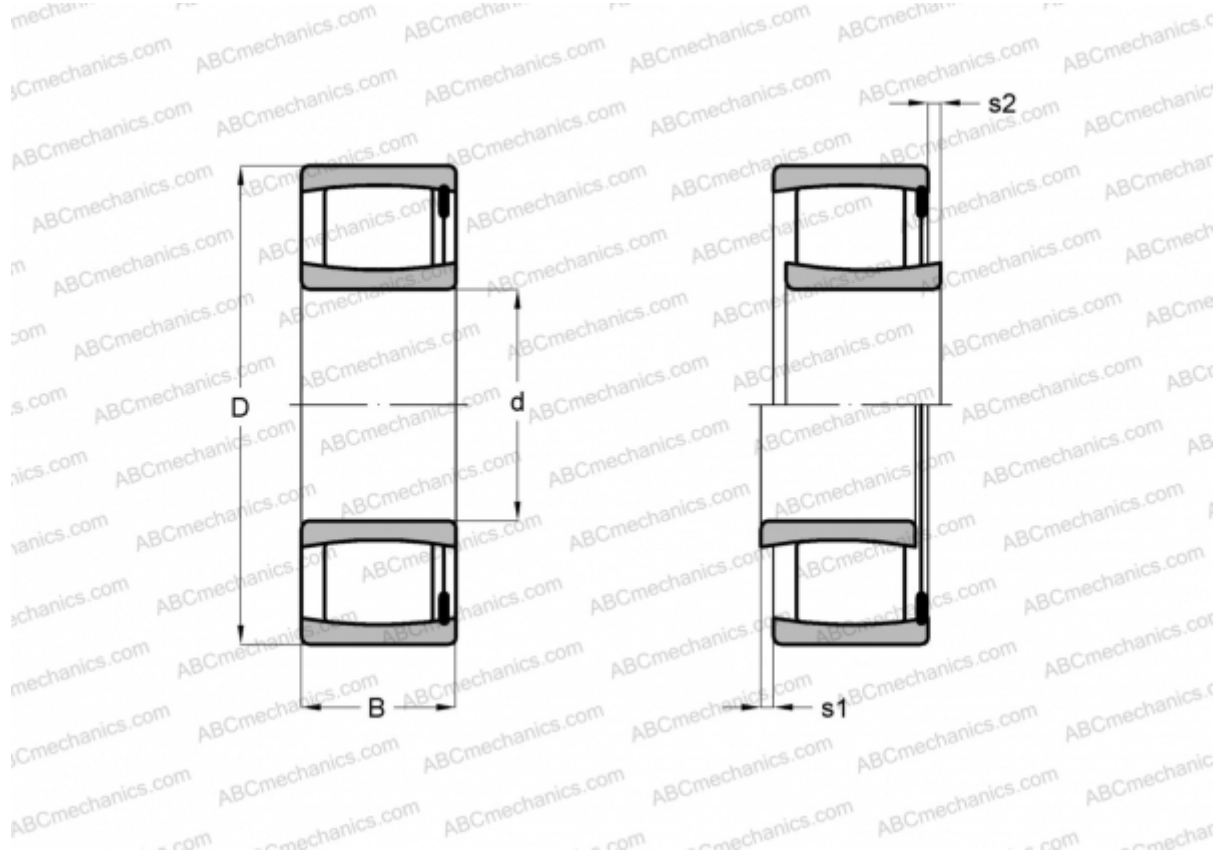

Technical specification

DIMENSIONS, MM

d	55,000
D	80,000
B	25,000

WEIGHT, KG 0,430

MANUFACTURER [SKF](#)

CALCULATION DATA

Basic dynamic load rating, C	106,000 kN
Basic static load rating, Co	153,000 kN
Fatigue load limit, Pu	18,000 kN
Limiting speed	3200 r/min