

C 5911 V SKF

CARB toroidal roller bearings

TYPE: Roller bearings, Toroidal CARB, Full complement, cylindrical bore

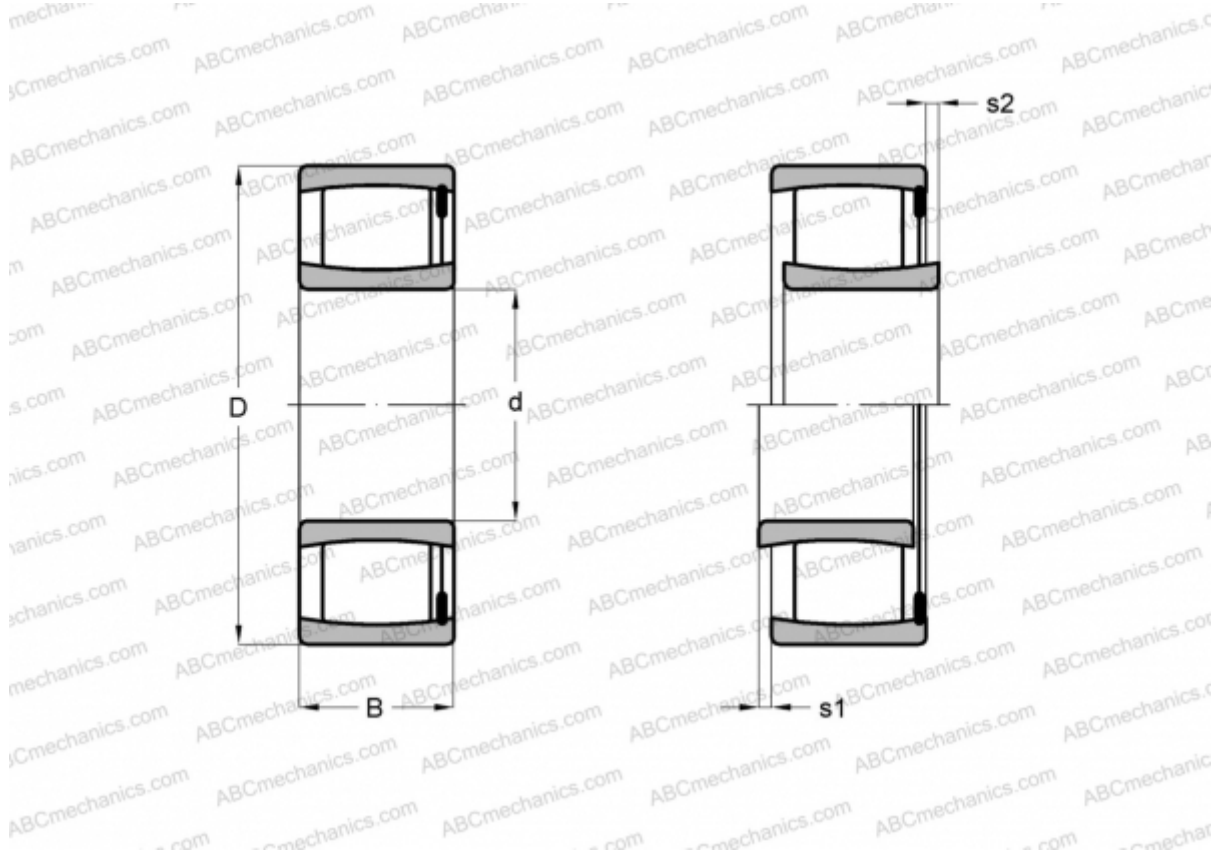

Technical specification

DIMENSIONS, MM

d	55,000
D	80,000
B	34,000

WEIGHT, KG 0,600

MANUFACTURER [SKF](#)

CALCULATION DATA

Basic dynamic load rating, C	143,000 kN
Basic static load rating, Co	224,000 kN
Fatigue load limit, Pu	25,000 kN
Limiting speed	2600 r/min