

C 6911 V SKF

CARB toroidal roller bearings

TYPE: Roller bearings, Toroidal CARB, Full complement, cylindrical bore

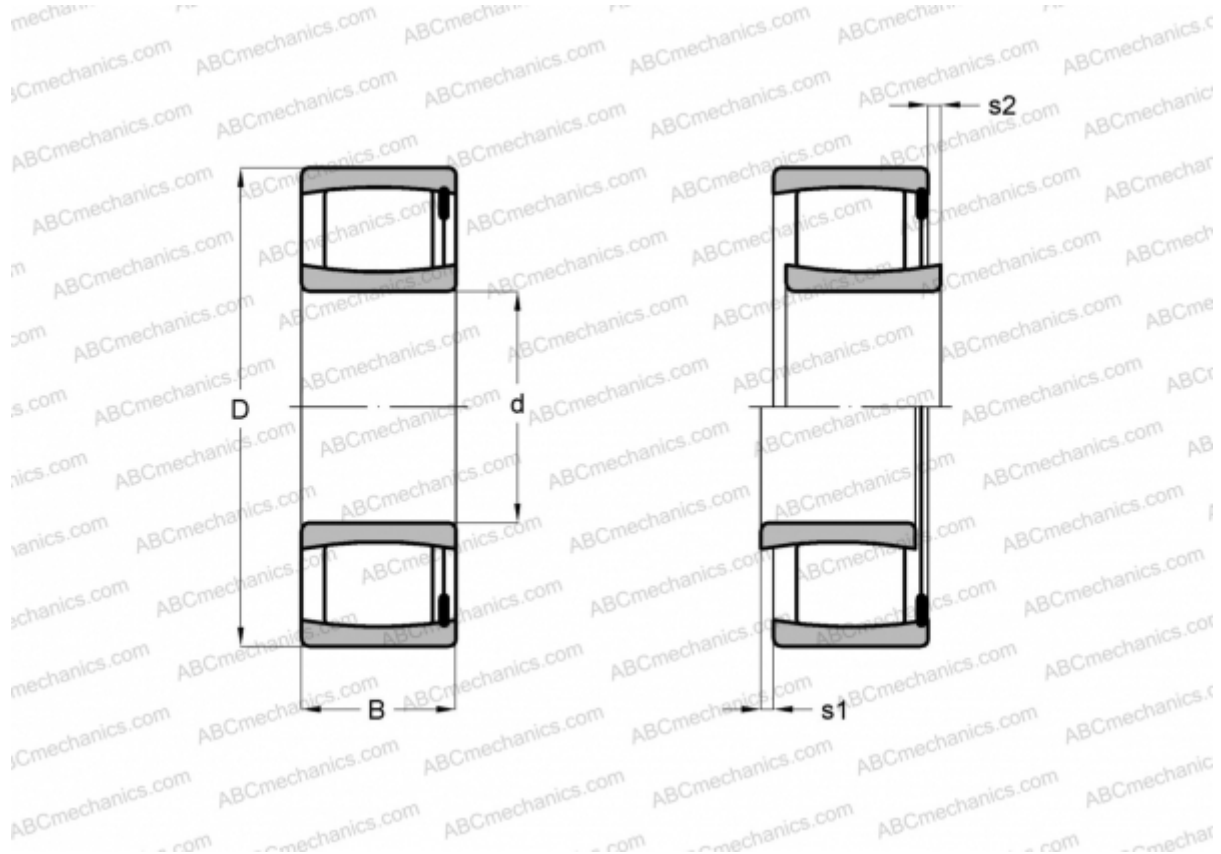

Technical specification

DIMENSIONS, MM

| | |
|---|--------|
| d | 55,000 |
| D | 80,000 |
| B | 45,000 |

WEIGHT, KG 0,810

MANUFACTURER [SKF](#)

CALCULATION DATA

| | |
|------------------------------|------------|
| Basic dynamic load rating, C | 180,000 kN |
| Basic static load rating, Co | 300,000 kN |
| Fatigue load limit, Pu | 32,500 kN |
| Limiting speed | 2000 r/min |