

C 5912 V SKF

CARB toroidal roller bearings

TYPE: Roller bearings, Toroidal CARB, Full complement, cylindrical bore

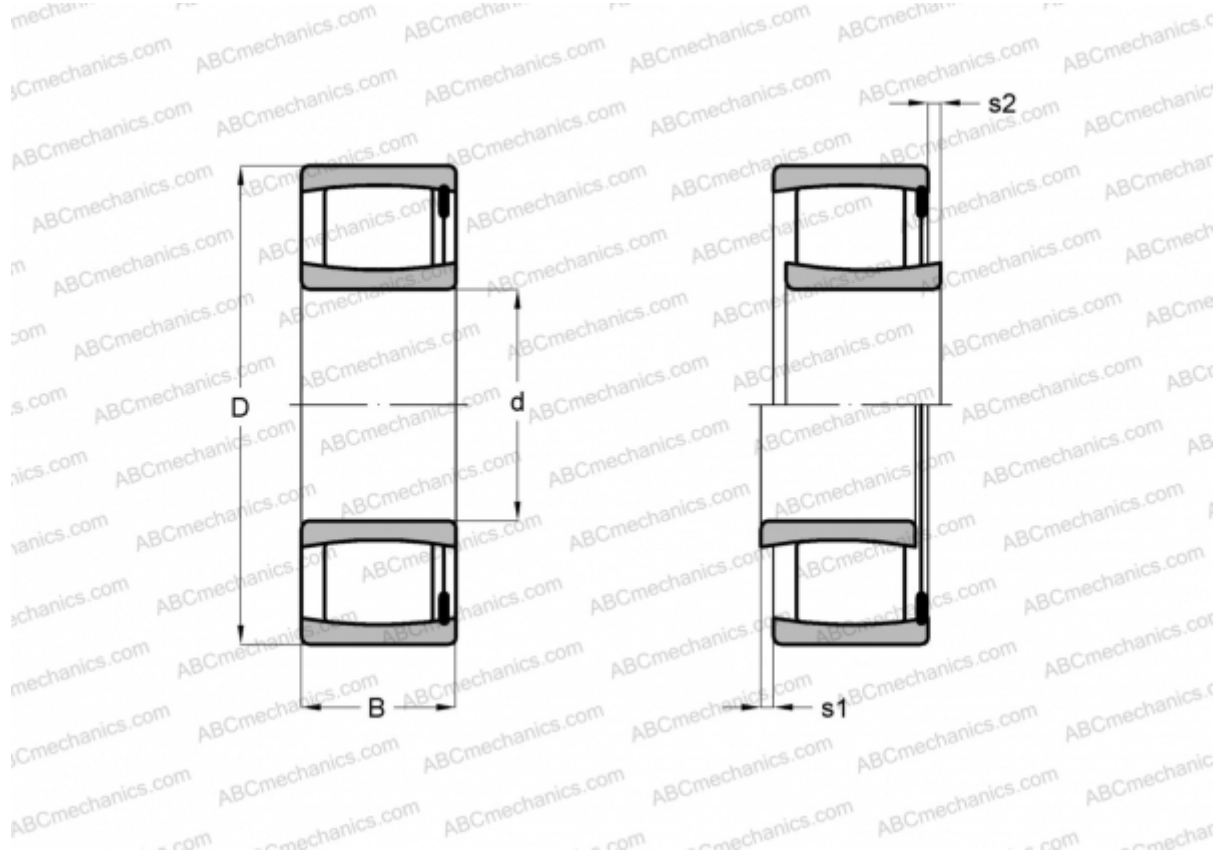

Technical specification

DIMENSIONS, MM

d	60,000
D	85,000
B	34,000

WEIGHT, KG 0,640

MANUFACTURER [SKF](#)

CALCULATION DATA

Basic dynamic load rating, C	150,000 kN
Basic static load rating, Co	240,000 kN
Fatigue load limit, Pu	26,500 kN
Limiting speed	2400 r/min