

C 6913 V SKF

CARB toroidal roller bearings

TYPE: Roller bearings, Toroidal CARB, Full complement, cylindrical bore

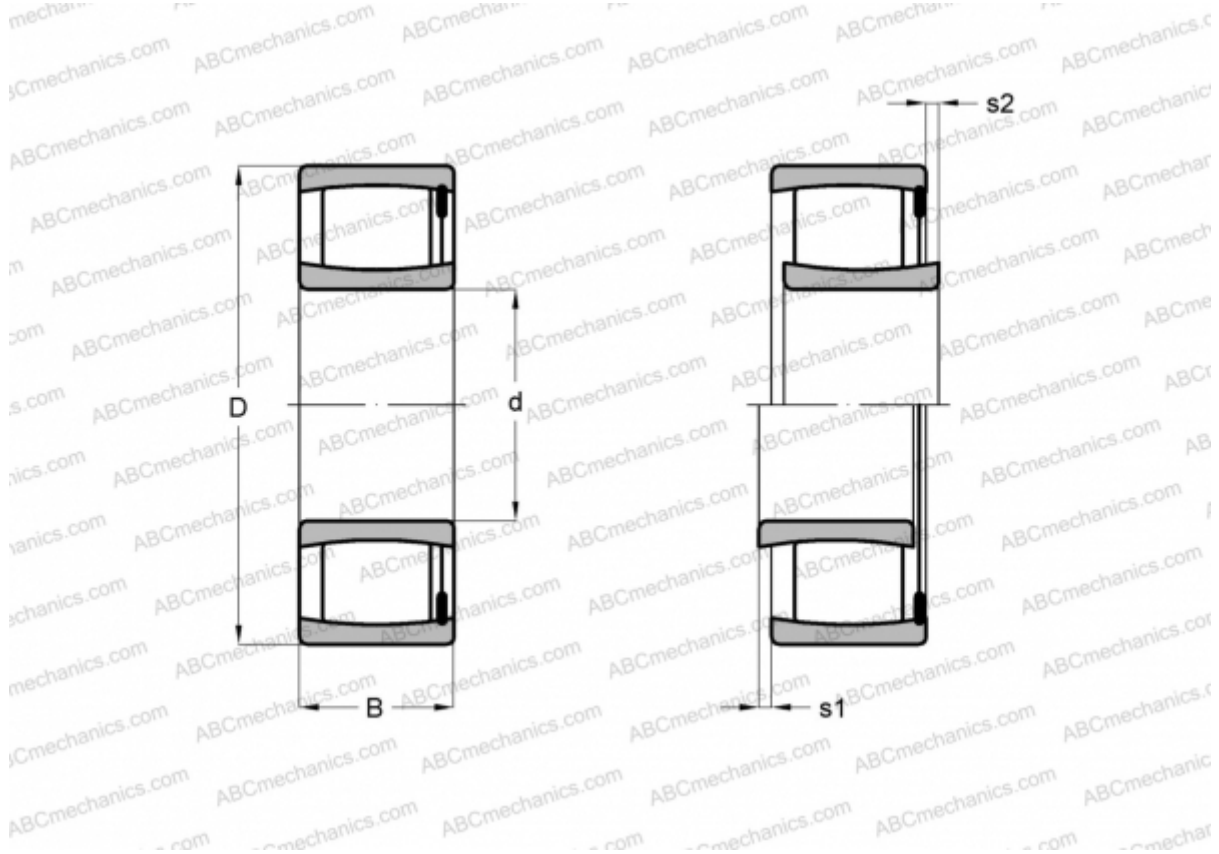

Technical specification

DIMENSIONS, MM

d	65,000
D	90,000
B	45,000

WEIGHT, KG 0,930

MANUFACTURER [SKF](#)

CALCULATION DATA

Basic dynamic load rating, C	196,000 kN
Basic static load rating, Co	355,000 kN
Fatigue load limit, Pu	38,000 kN
Limiting speed	1800 r/min