

C 4013 V SKF

CARB toroidal roller bearings

TYPE: Roller bearings, Toroidal CARB, Full complement, cylindrical bore

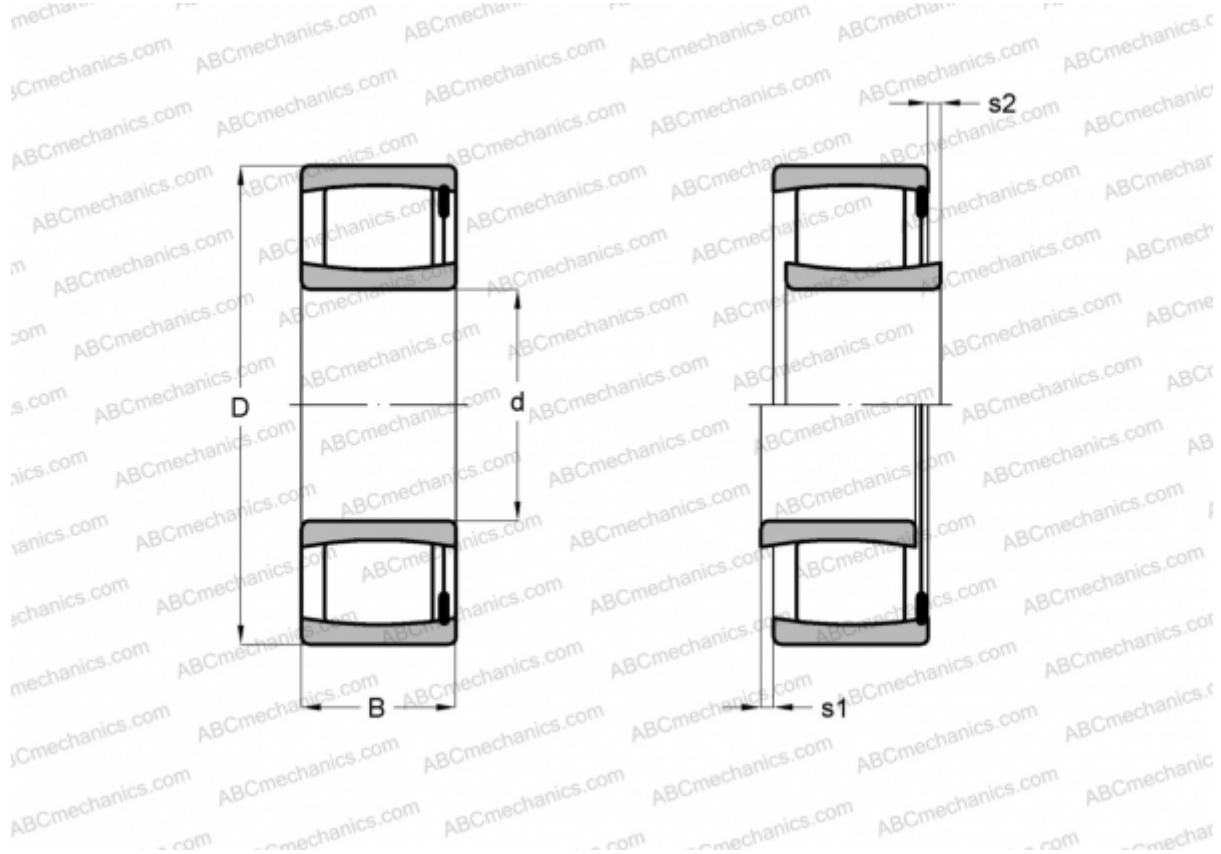

Technical specification

DIMENSIONS, MM

d	65,000
D	100,000
B	35,000

WEIGHT, KG 1,000

MANUFACTURER [SKF](#)

CALCULATION DATA

Basic dynamic load rating, C	196,000 kN
Basic static load rating, Co	275,000 kN
Fatigue load limit, Pu	32,000 kN
Limiting speed	2400 r/min