

## C 5914 V SKF

CARB toroidal roller bearings

TYPE: Roller bearings, Toroidal CARB, Full complement, cylindrical bore

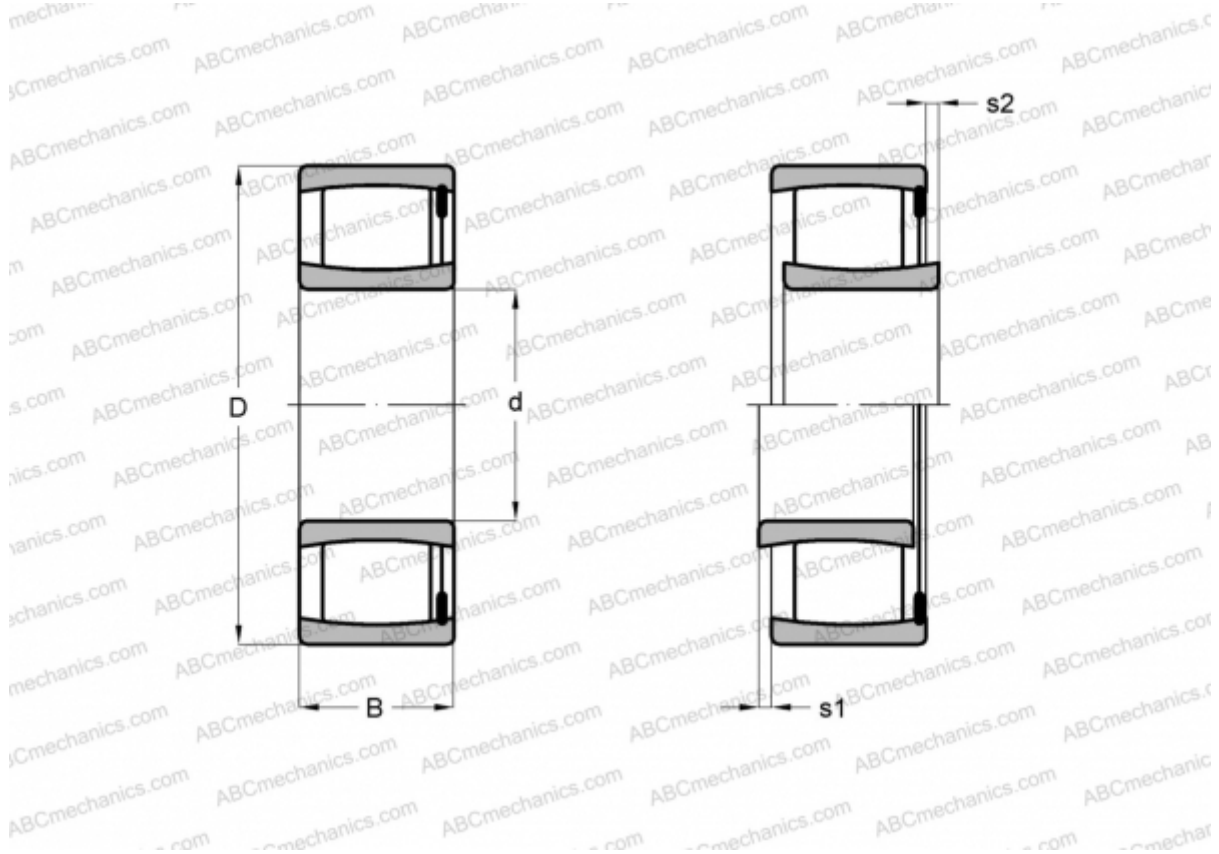

### Technical specification

#### DIMENSIONS, MM

d	70,000
D	100,000
B	40,000

**WEIGHT, KG** 1,000

**MANUFACTURER** [SKF](#)

#### CALCULATION DATA

Basic dynamic load rating, C	196,000 kN
Basic static load rating, Co	310,000 kN
Fatigue load limit, Pu	34,500 kN
Limiting speed	2000 r/min