

C 6914 V SKF

CARB toroidal roller bearings

TYPE: Roller bearings, Toroidal CARB, Full complement, cylindrical bore

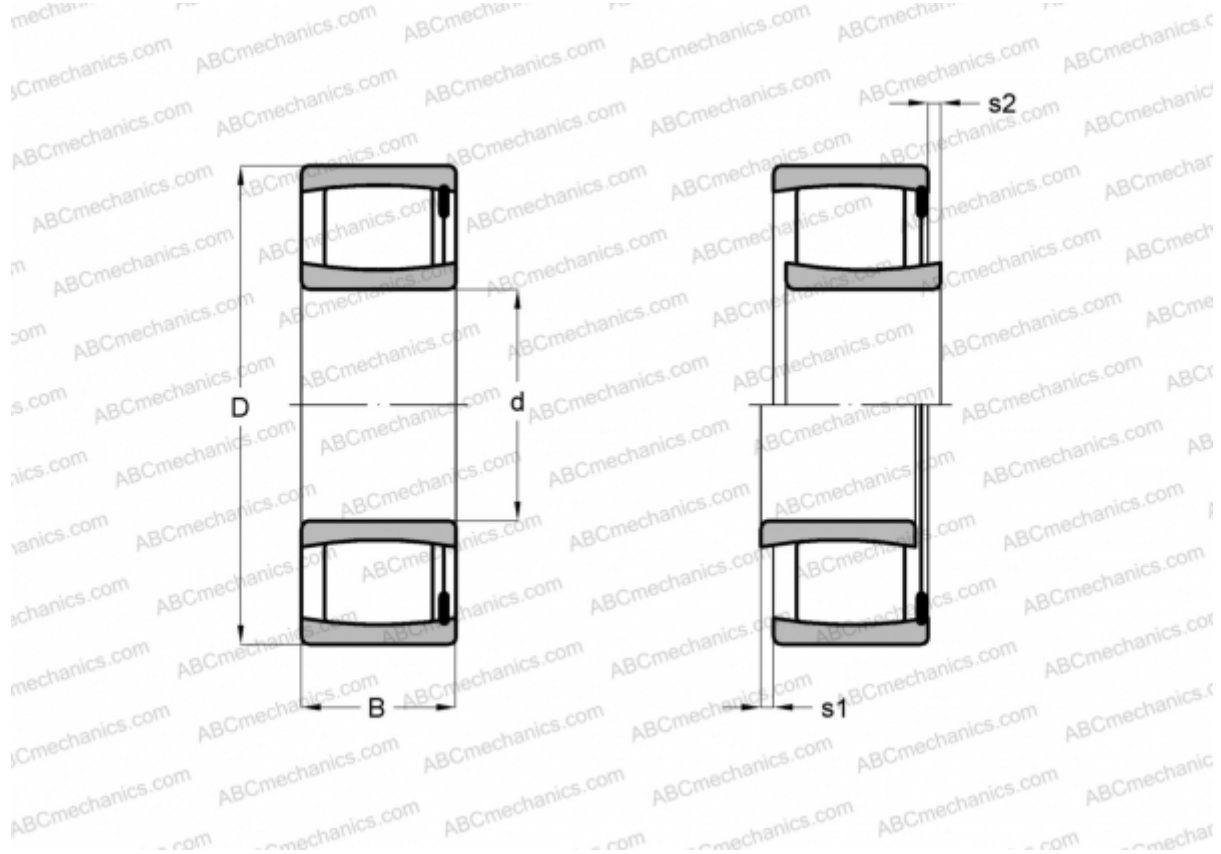

Technical specification

DIMENSIONS, MM

d	70,000
D	100,000
B	54,000

WEIGHT, KG 1,400

MANUFACTURER [SKF](#)

CALCULATION DATA

Basic dynamic load rating, C	265,000 kN
Basic static load rating, Co	455,000 kN
Fatigue load limit, Pu	49,000 kN
Limiting speed	1700 r/min