

C 5915 V SKF

CARB toroidal roller bearings

TYPE: Roller bearings, Toroidal CARB, Full complement, cylindrical bore

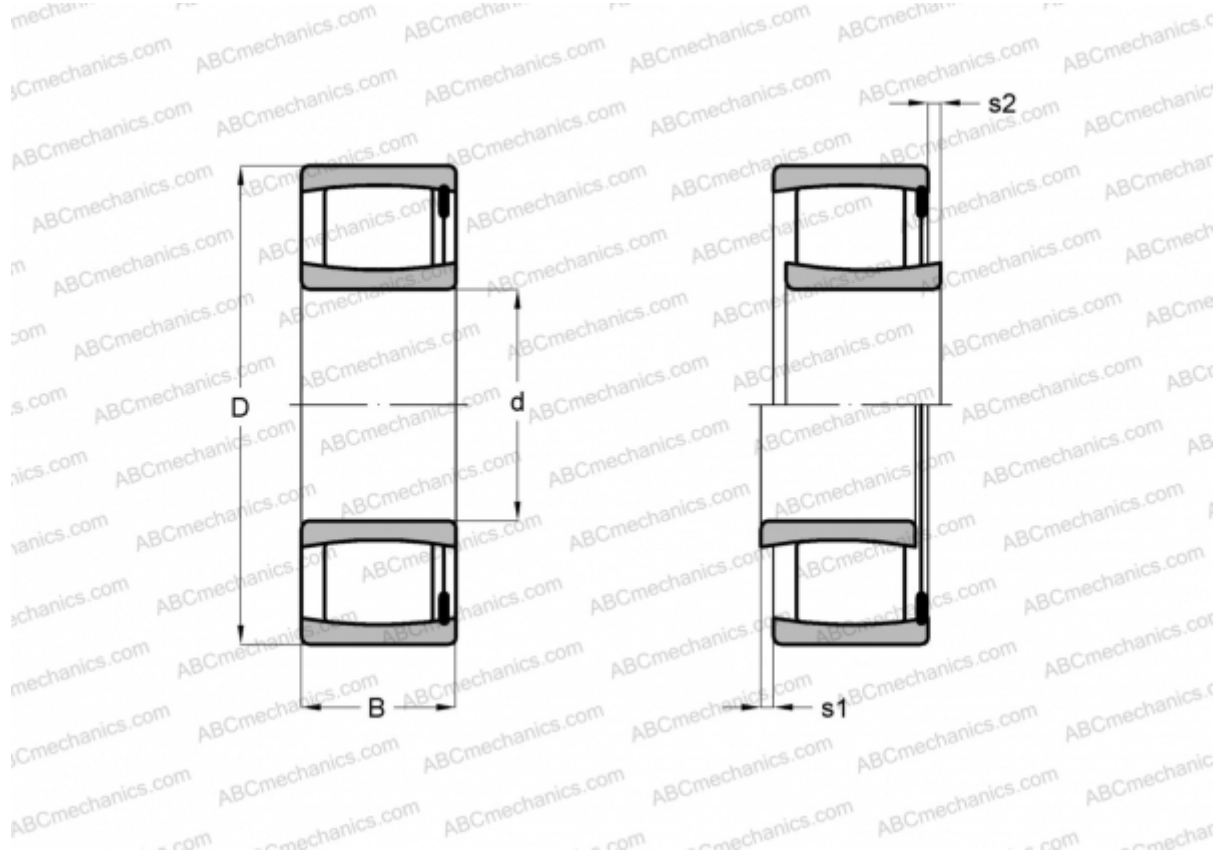

Technical specification

DIMENSIONS, MM

d	75,000
D	105,000
B	40,000

WEIGHT, KG 1,100

MANUFACTURER [SKF](#)

CALCULATION DATA

Basic dynamic load rating, C	204,000 kN
Basic static load rating, Co	325,000 kN
Fatigue load limit, Pu	37,500 kN
Limiting speed	1900 r/min