

C 4015 V SKF

CARB toroidal roller bearings

TYPE: Roller bearings, Toroidal CARB, Full complement, cylindrical bore

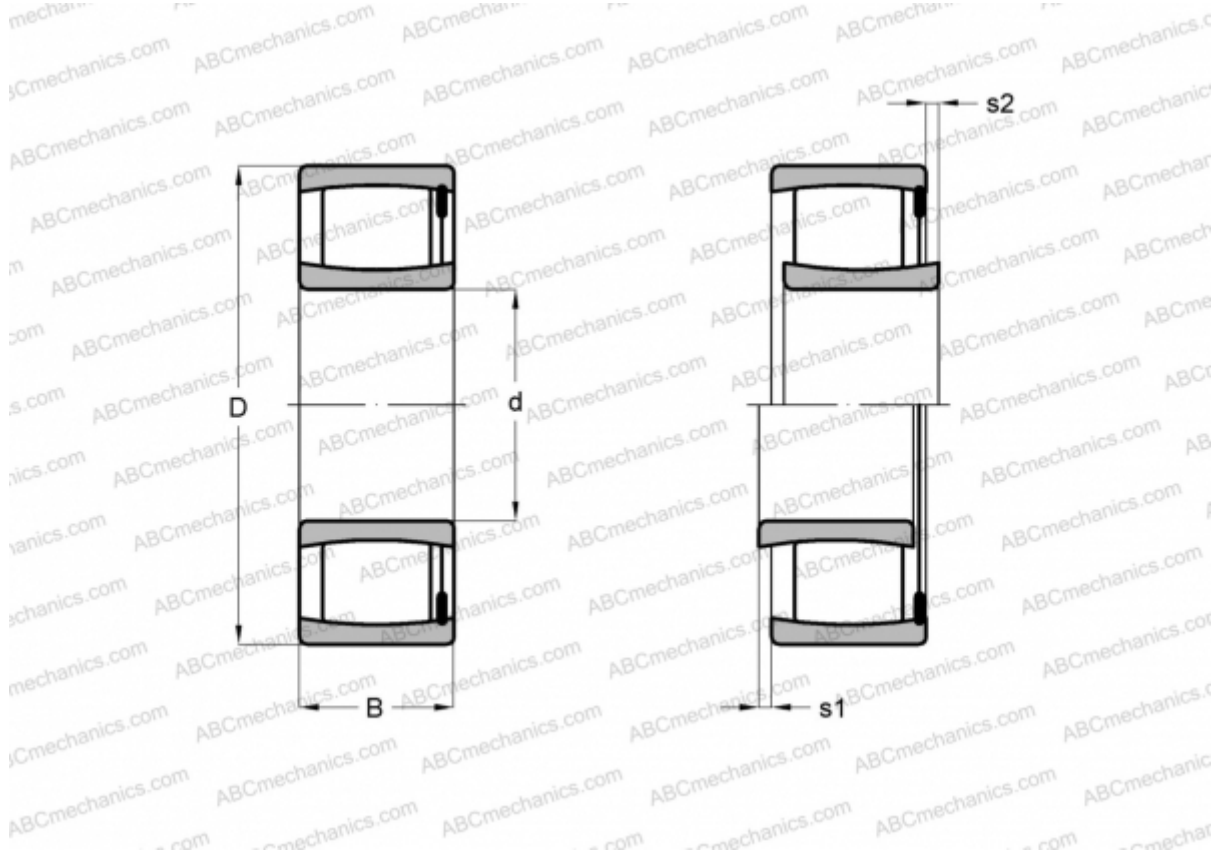

Technical specification

DIMENSIONS, MM

d	75,000
D	115,000
B	40,000

WEIGHT, KG 1,500

MANUFACTURER [SKF](#)

CALCULATION DATA

Basic dynamic load rating, C	236,000 kN
Basic static load rating, Co	345,000 kN
Fatigue load limit, Pu	40,000 kN
Limiting speed	2000 r/min