

C 4916 V SKF

CARB toroidal roller bearings

TYPE: Roller bearings, Toroidal CARB, Full complement, cylindrical bore

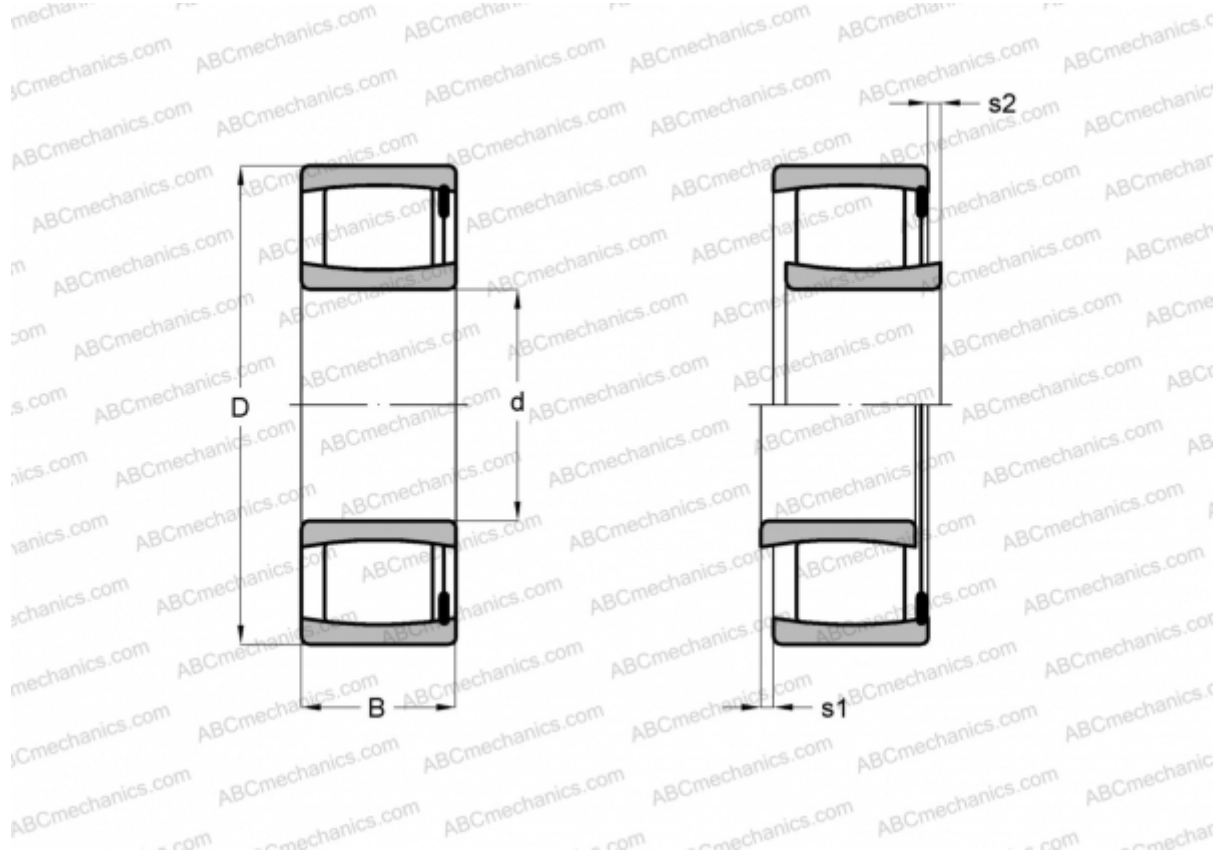

Technical specification

DIMENSIONS, MM

d	80,000
D	110,000
B	30,000

WEIGHT, KG 0,870

MANUFACTURER [SKF](#)

CALCULATION DATA

Basic dynamic load rating, C	173,000 kN
Basic static load rating, Co	275,000 kN
Fatigue load limit, Pu	31,500 kN
Limiting speed	2200 r/min