

## C 5916 V SKF

CARB toroidal roller bearings

TYPE: Roller bearings, Toroidal CARB, Full complement, cylindrical bore

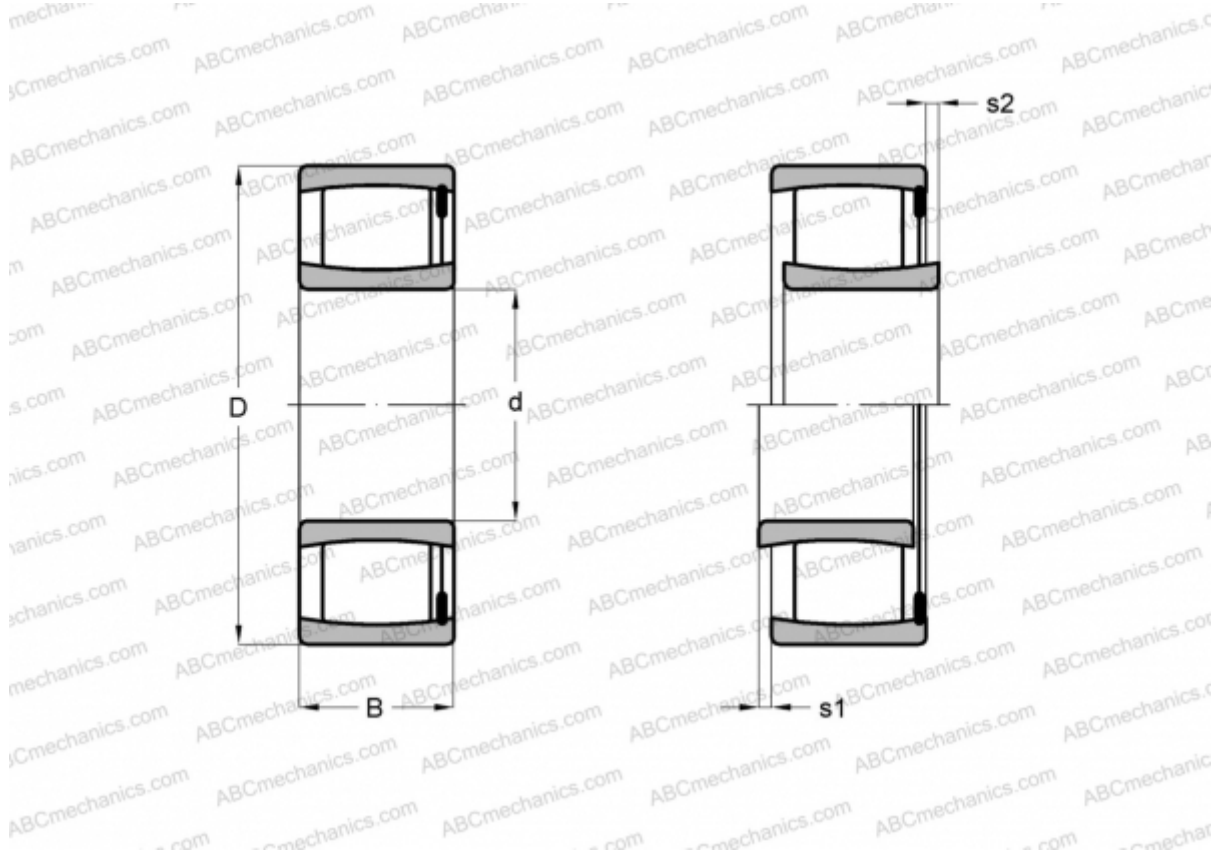

### Technical specification

#### DIMENSIONS, MM

d	80,000
D	110,000
B	40,000

**WEIGHT, KG** 1,200

**MANUFACTURER** [SKF](#)

#### CALCULATION DATA

Basic dynamic load rating, C	208,000 kN
Basic static load rating, Co	345,000 kN
Fatigue load limit, Pu	40,000 kN
Limiting speed	1800 r/min