

C 5917 V SKF

CARB toroidal roller bearings

TYPE: Roller bearings, Toroidal CARB, Full complement, cylindrical bore

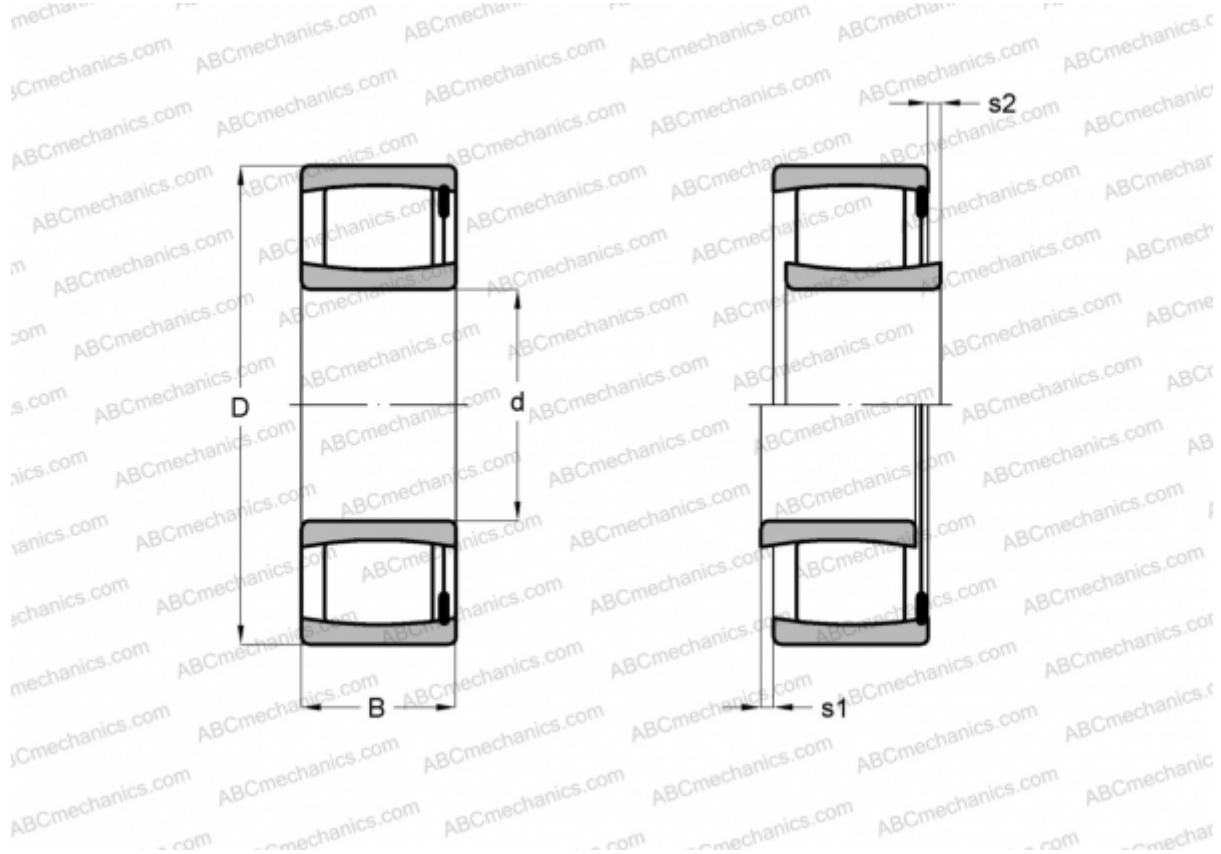

Technical specification

DIMENSIONS, MM

d	85,000
D	120,000
B	46,000

WEIGHT, KG 1,700

MANUFACTURER [SKF](#)

CALCULATION DATA

Basic dynamic load rating, C	275,000 kN
Basic static load rating, Co	465,000 kN
Fatigue load limit, Pu	52,000 kN
Limiting speed	1700 r/min