

## C 5918 V SKF

CARB toroidal roller bearings

TYPE: Roller bearings, Toroidal CARB, Full complement, cylindrical bore

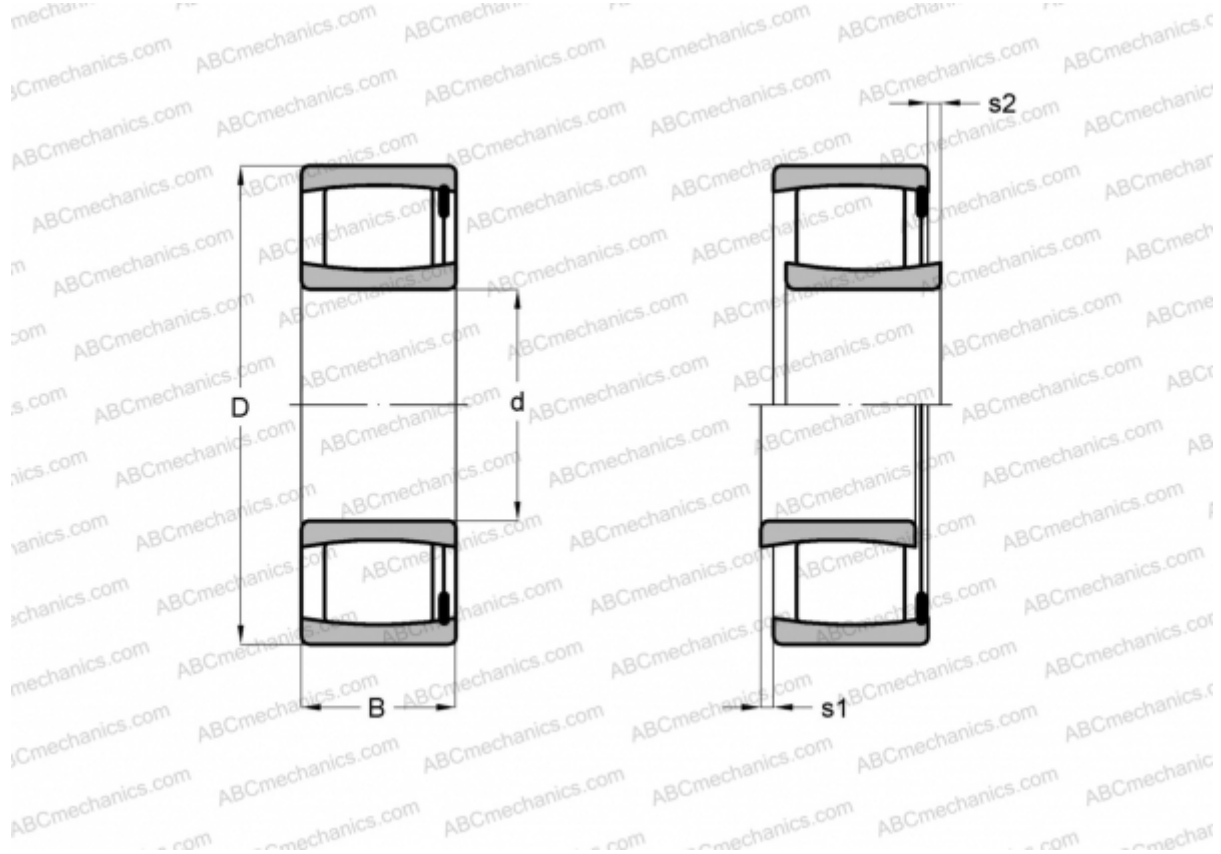

### Technical specification

#### DIMENSIONS, MM

d	90,000
D	125,000
B	46,000

**WEIGHT, KG** 1,750

**MANUFACTURER** [SKF](#)

#### CALCULATION DATA

Basic dynamic load rating, C	224,000 kN
Basic static load rating, Co	400,000 kN
Fatigue load limit, Pu	44,000 kN
Limiting speed	1600 r/min