

## C 4020 V SKF

CARB toroidal roller bearings

TYPE: Roller bearings, Toroidal CARB, Full complement, cylindrical bore

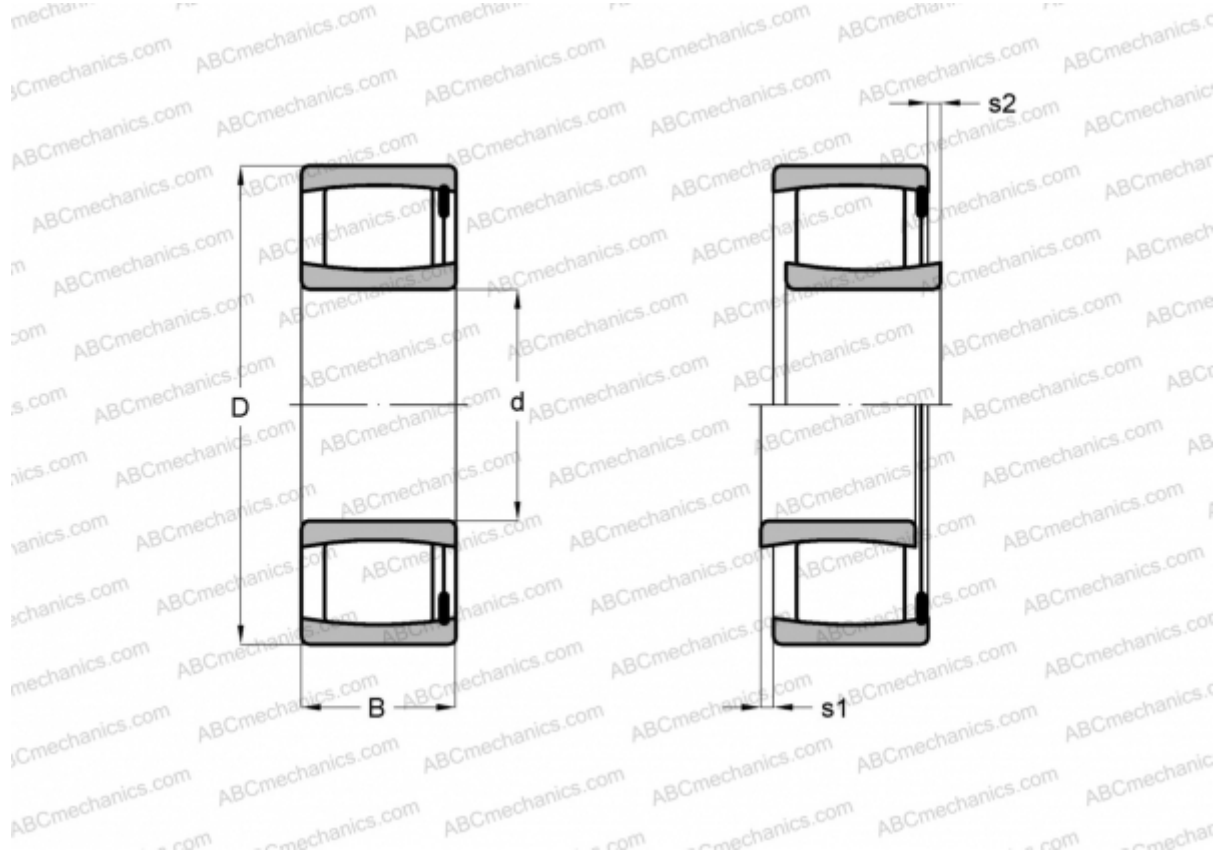

### Technical specification

#### DIMENSIONS, MM

d	100,000
D	150,000
B	50,000

**WEIGHT, KG** 3,050

**MANUFACTURER** [SKF](#)

#### CALCULATION DATA

Basic dynamic load rating, C	355,000 kN
Basic static load rating, Co	530,000 kN
Fatigue load limit, Pu	57,000 kN
Limiting speed	1400 r/min