

C 5020 V SKF

CARB toroidal roller bearings

TYPE: Roller bearings, Toroidal CARB, Full complement, cylindrical bore

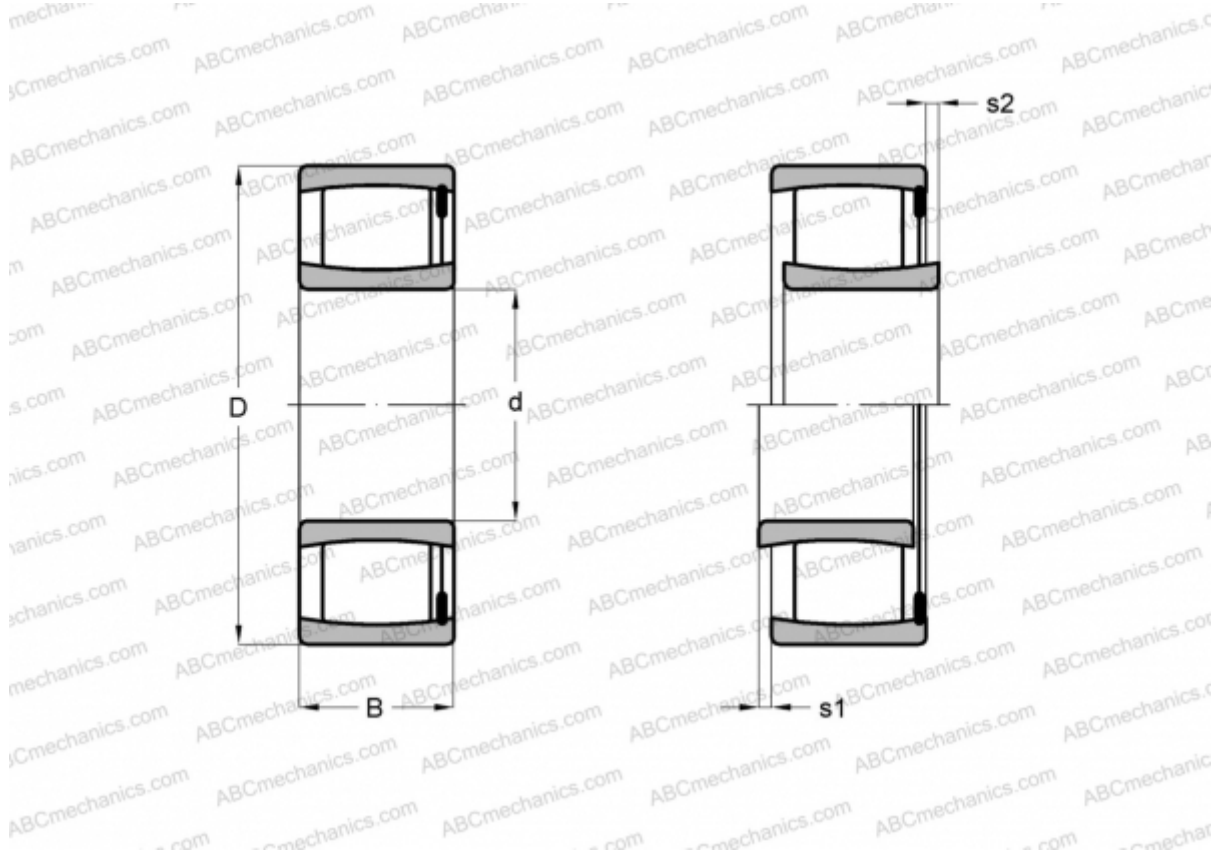

Technical specification

DIMENSIONS, MM

d	100,000
D	150,000
B	67,000

WEIGHT, KG 4,300

MANUFACTURER [SKF](#)

CALCULATION DATA

Basic dynamic load rating, C	510,000 kN
Basic static load rating, Co	865,000 kN
Fatigue load limit, Pu	90,000 kN
Limiting speed	1100 r/min