

C 4026 V SKF

CARB toroidal roller bearings

TYPE: Roller bearings, Toroidal CARB, Full complement, cylindrical bore

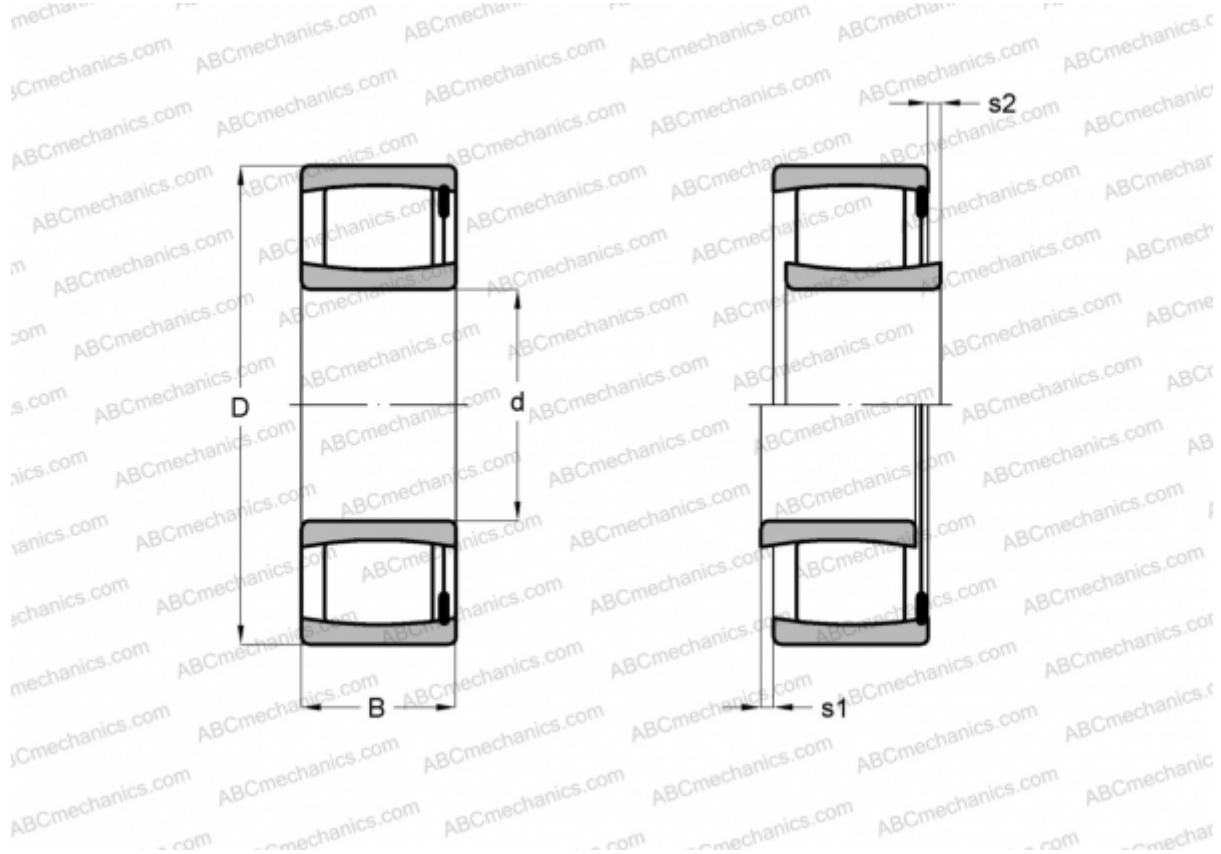

Technical specification

DIMENSIONS, MM

d	130,000
D	200,000
B	69,000

WEIGHT, KG 8,050

MANUFACTURER [SKF](#)

CALCULATION DATA

Basic dynamic load rating, C	720,000 kN
Basic static load rating, Co	1120,000 kN
Fatigue load limit, Pu	112,000 kN
Limiting speed	850 r/min