

C 4028 V SKF

CARB toroidal roller bearings

TYPE: Roller bearings, Toroidal CARB, Full complement, cylindrical bore

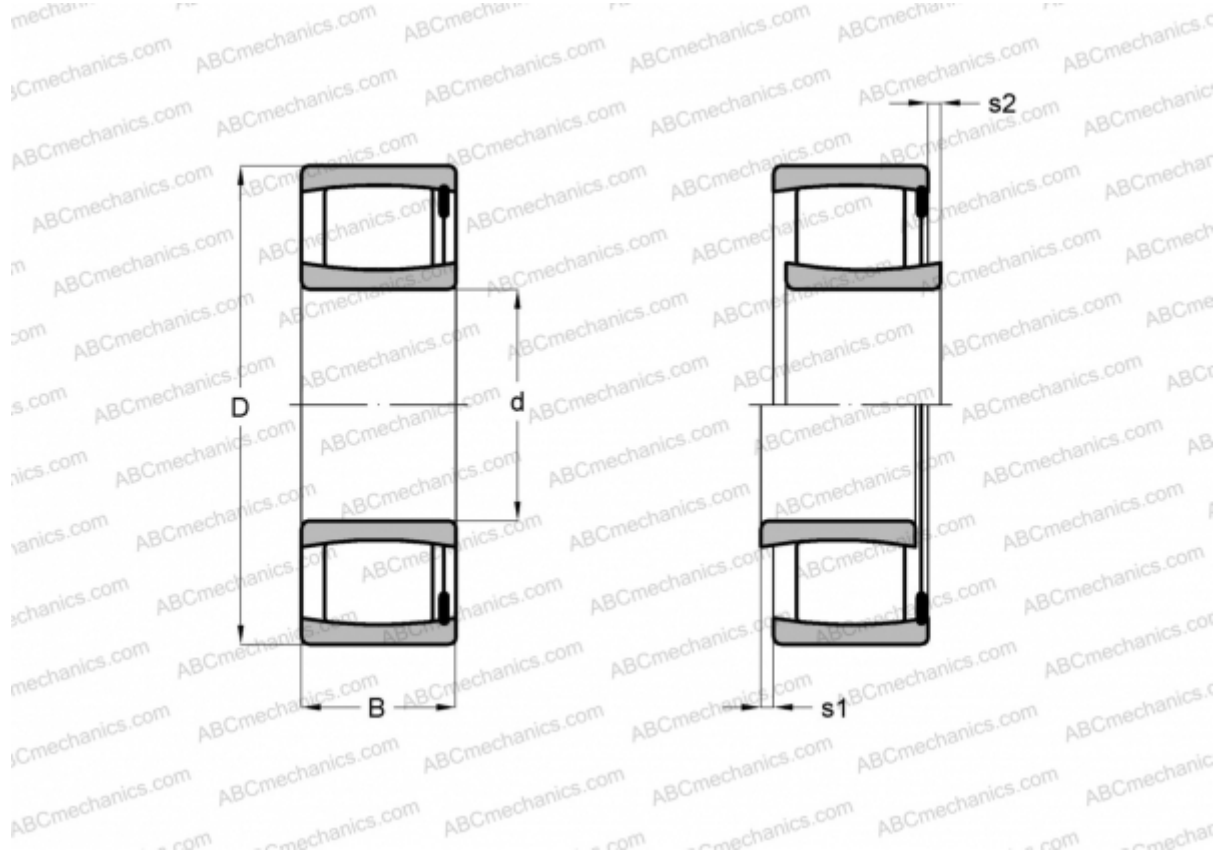

Technical specification

DIMENSIONS, MM

d	140,000
D	210,000
B	69,000

WEIGHT, KG 8,550

MANUFACTURER [SKF](#)

CALCULATION DATA

Basic dynamic load rating, C	750,000 kN
Basic static load rating, Co	1220,000 kN
Fatigue load limit, Pu	118,000 kN
Limiting speed	800 r/min